

## ATENÇÃO

Configure sua impressora **ANTES DE IMPRIMIR!!!!!!**

### 1º Passo

- Clique em **ARQUIVO/IMPRIMIR** e observe que o programa da impressora - **AUTOMATICAMENTE** - ajusta a área a ser impressa. (Figura 1)

### 2º Passo

- Corrija a configuração da impressão **MODIFICANDO** a opção que está marcada no item **«REDIMENSIONAMENTO DE PÁGINAS»** para a opção **«NENHUM»**. (Figura 2)

### 3º Passo

- Imprima apenas **UMA FOLHA** para teste e verifique se a grade tracejada está com as seguintes medidas:

**18cm de Largura por 26cm de Comprimento.**

### 4º Passo

- Caso esteja correto imprima, o restante das folhas e faça a união conforme a orientação para Moldes On-Line. Recorte as peças do Molde e siga as instruções de Corte e Costura.

Figura 1



Figura 2



## Colete Masculino Tamanho 38

Referência	Co003
Data	25/05/2010
Tamanho	38
Sugestão de Tecido	Brim
Metragem	0,70m de Tecido Xadrez e 0,80m de Tecido Liso, todos com 1,40m de Largura.
Material	5 Botões de 2cm
Preço do Molde para adquirir em outro Tamanho.	R\$ 3,00

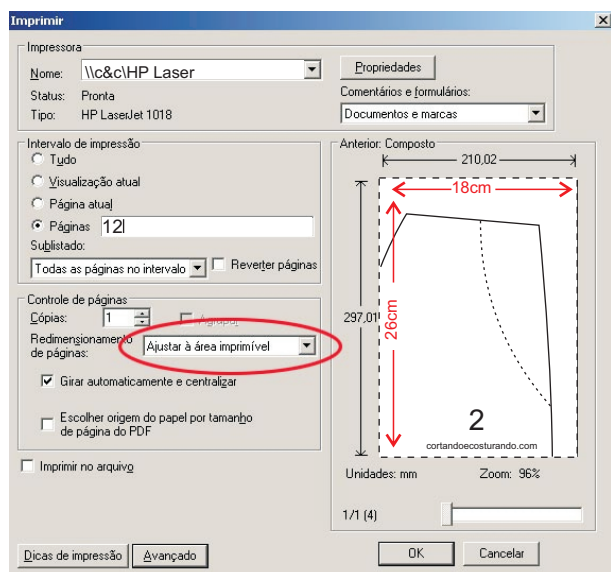
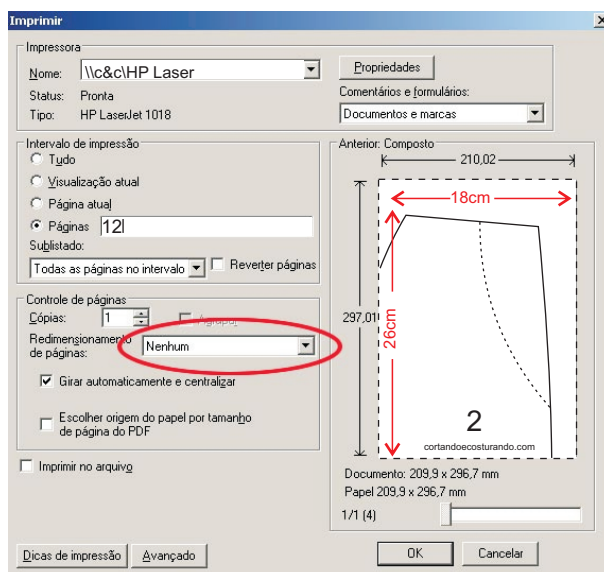
### Desenho Técnico

FRENTE

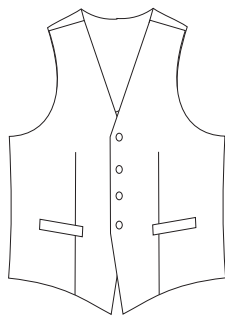

COSTAS

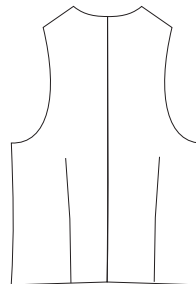

Tecido Xadrez

Ourela

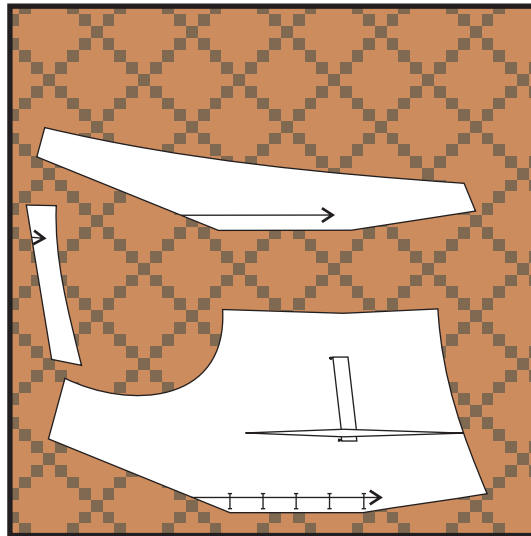

Dobra do Tecido

Tecido Liso

Ourela

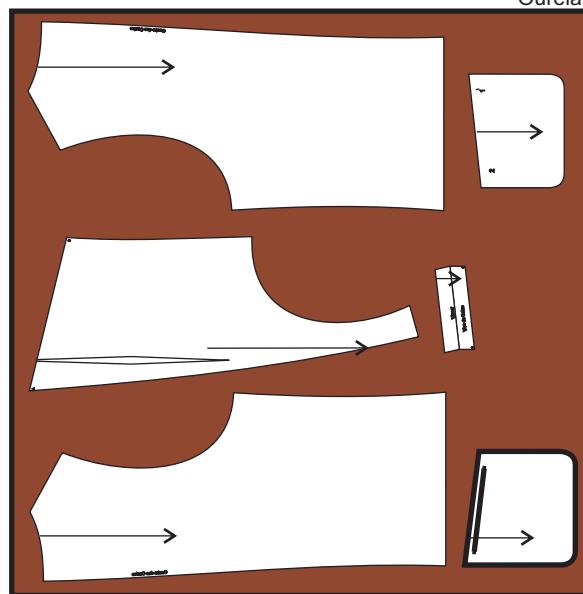

Dobra do Tecido

Entretela

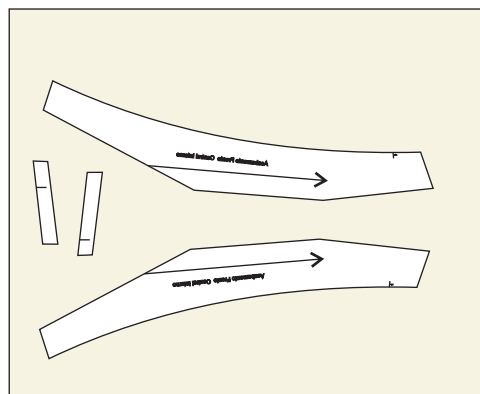

# Grade Completa

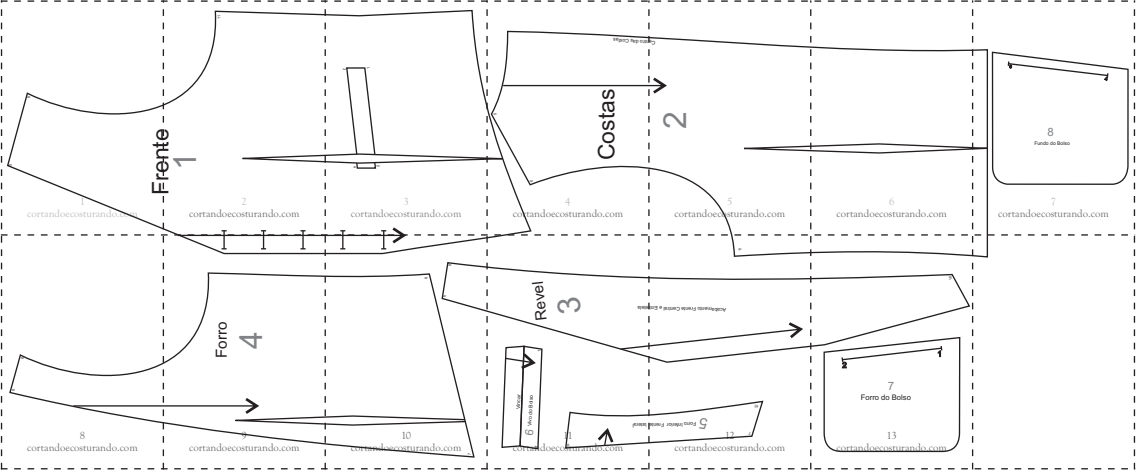

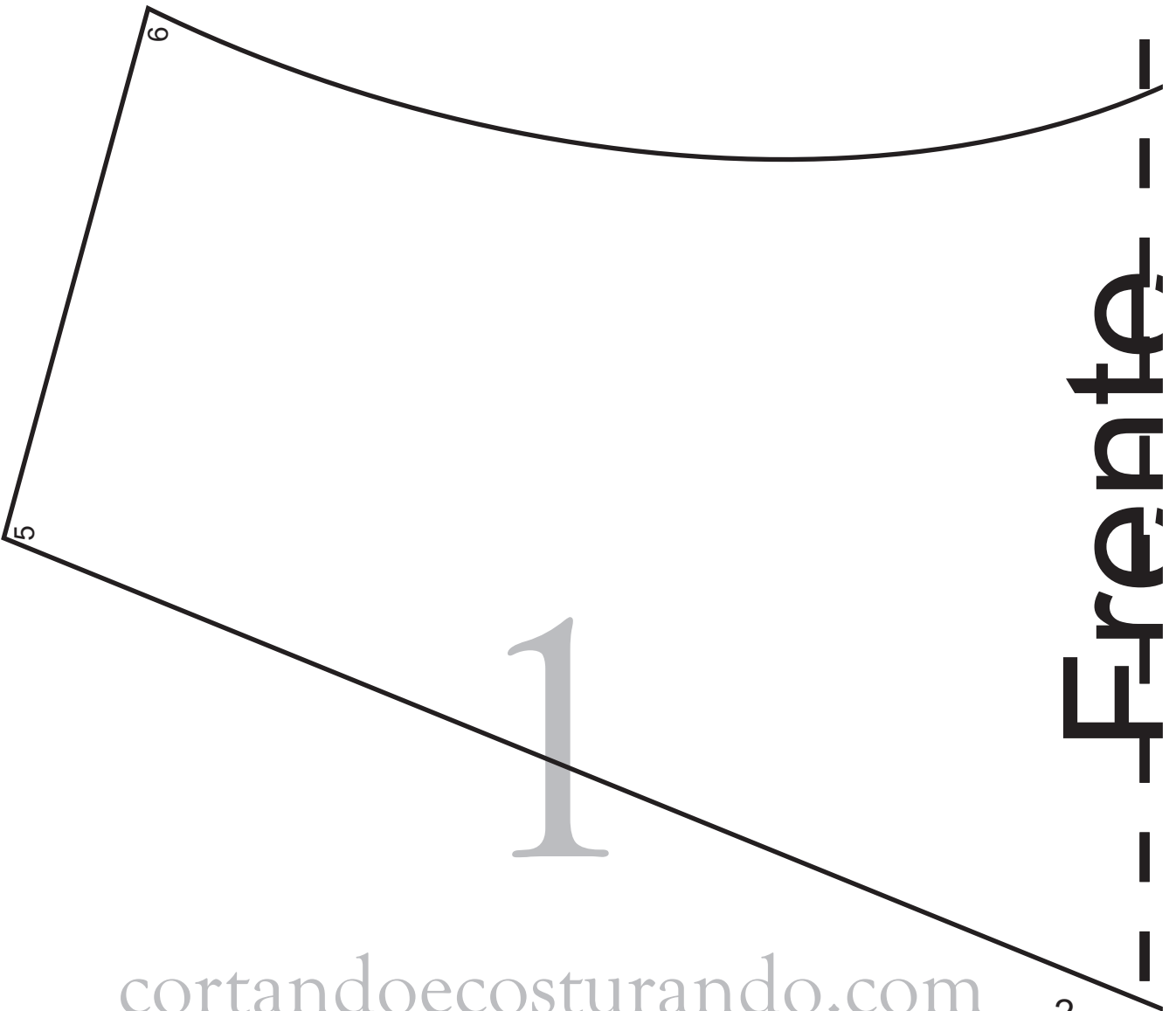
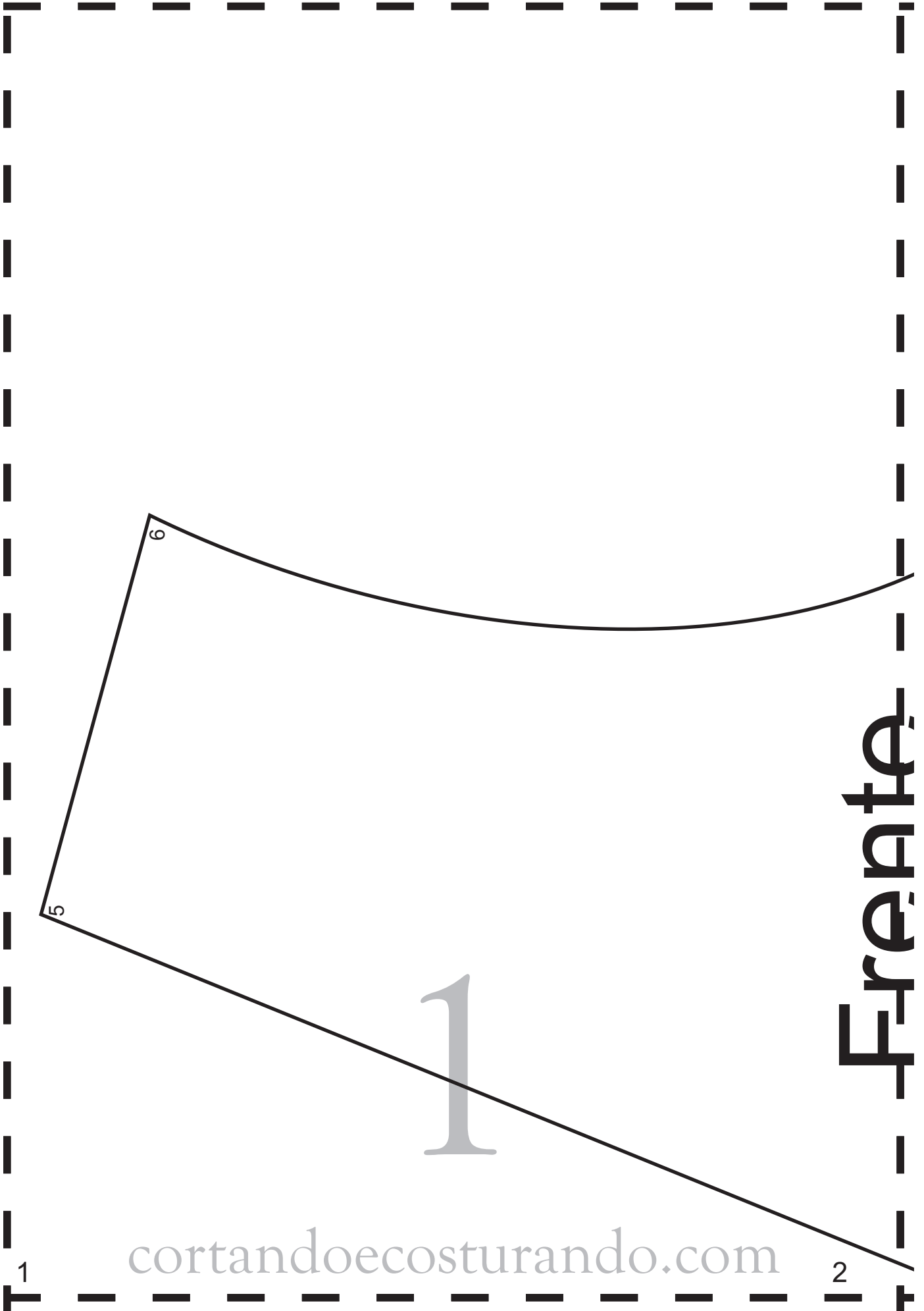

Frente

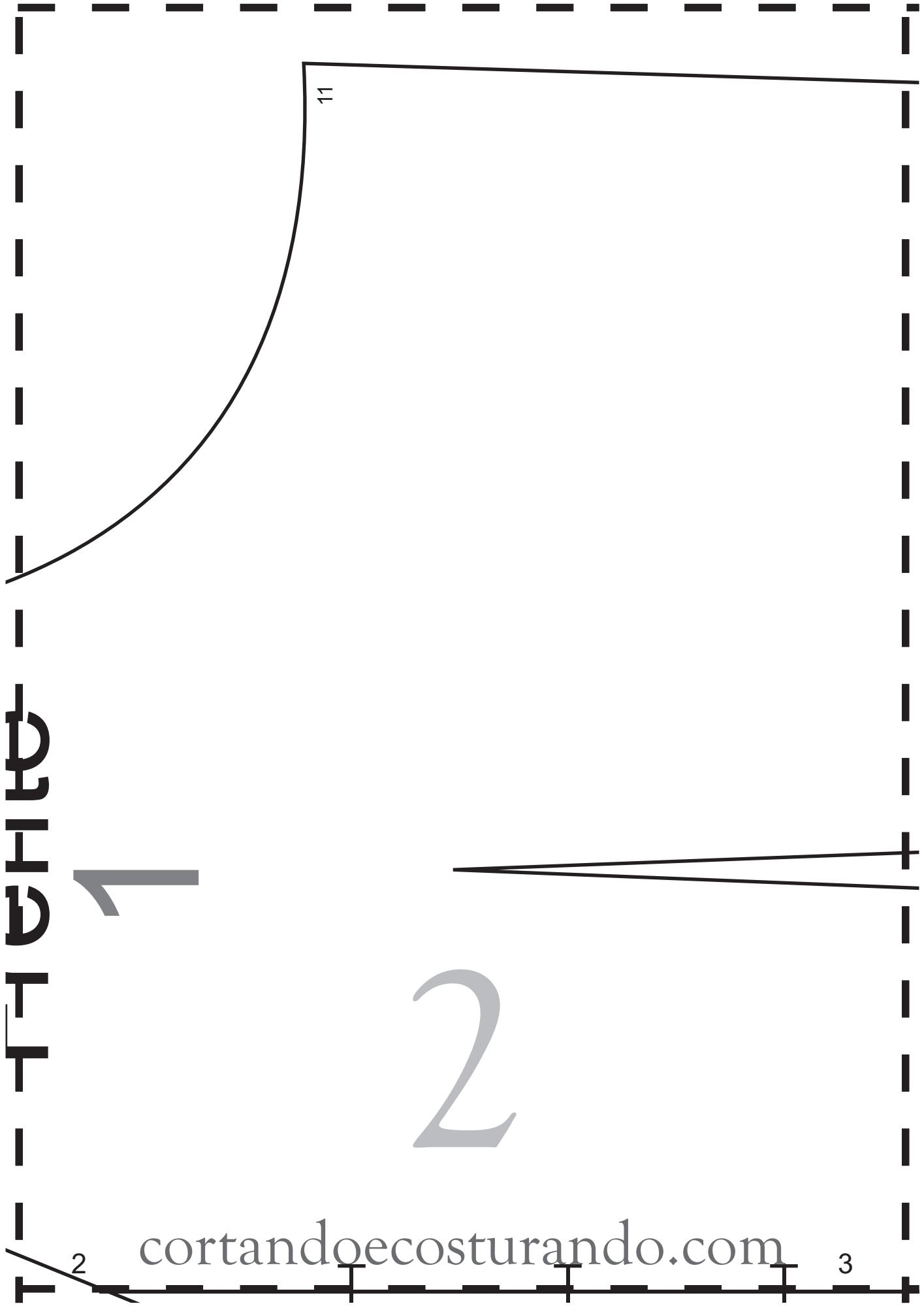

11

1

2

2

3

cortandoecosturando.com

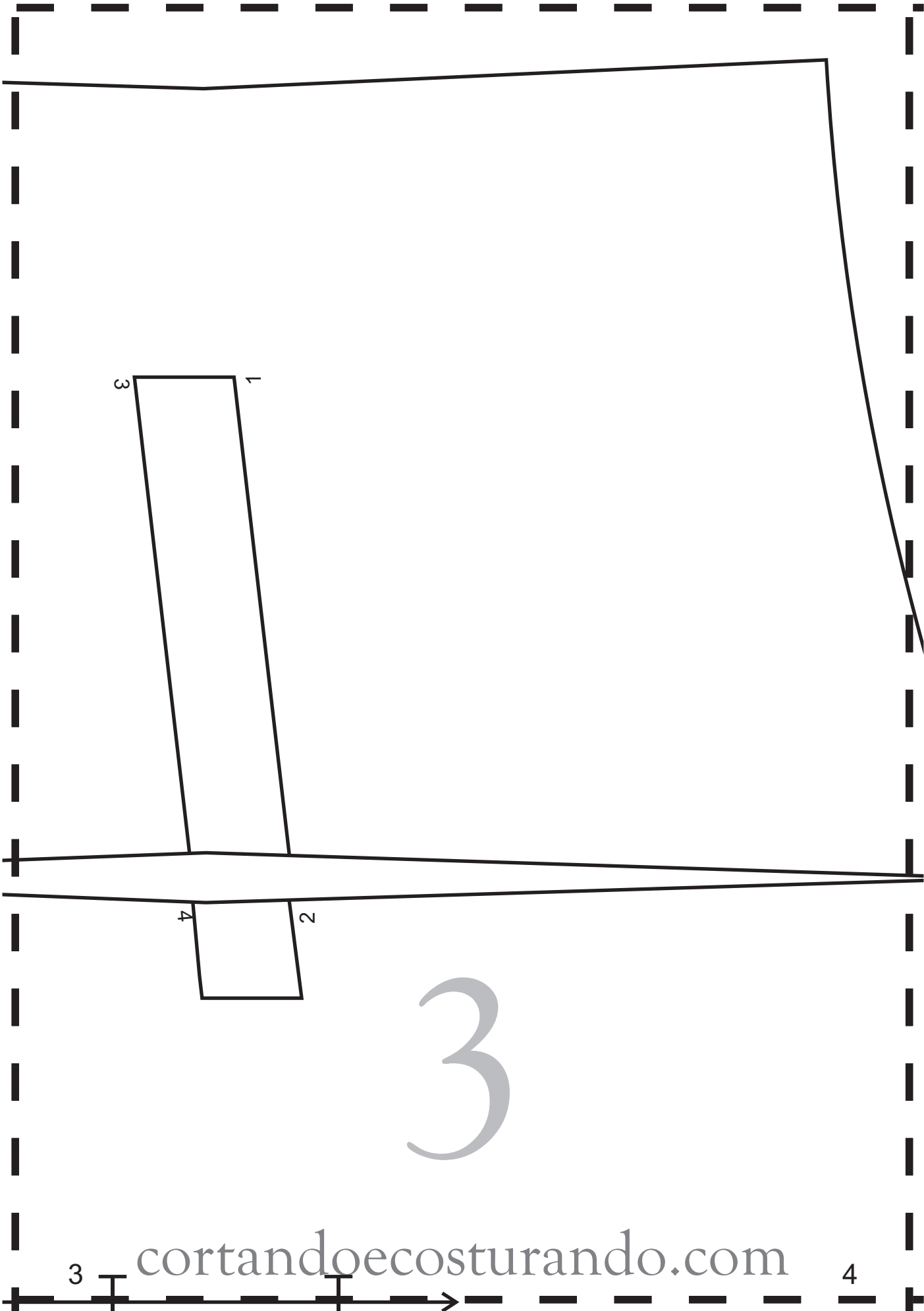

cortandoeecosturando.com

3

4

# Costas

4

[cortandoecosturando.com](http://cortandoecosturando.com)

entro das Costas

5

6

4

5

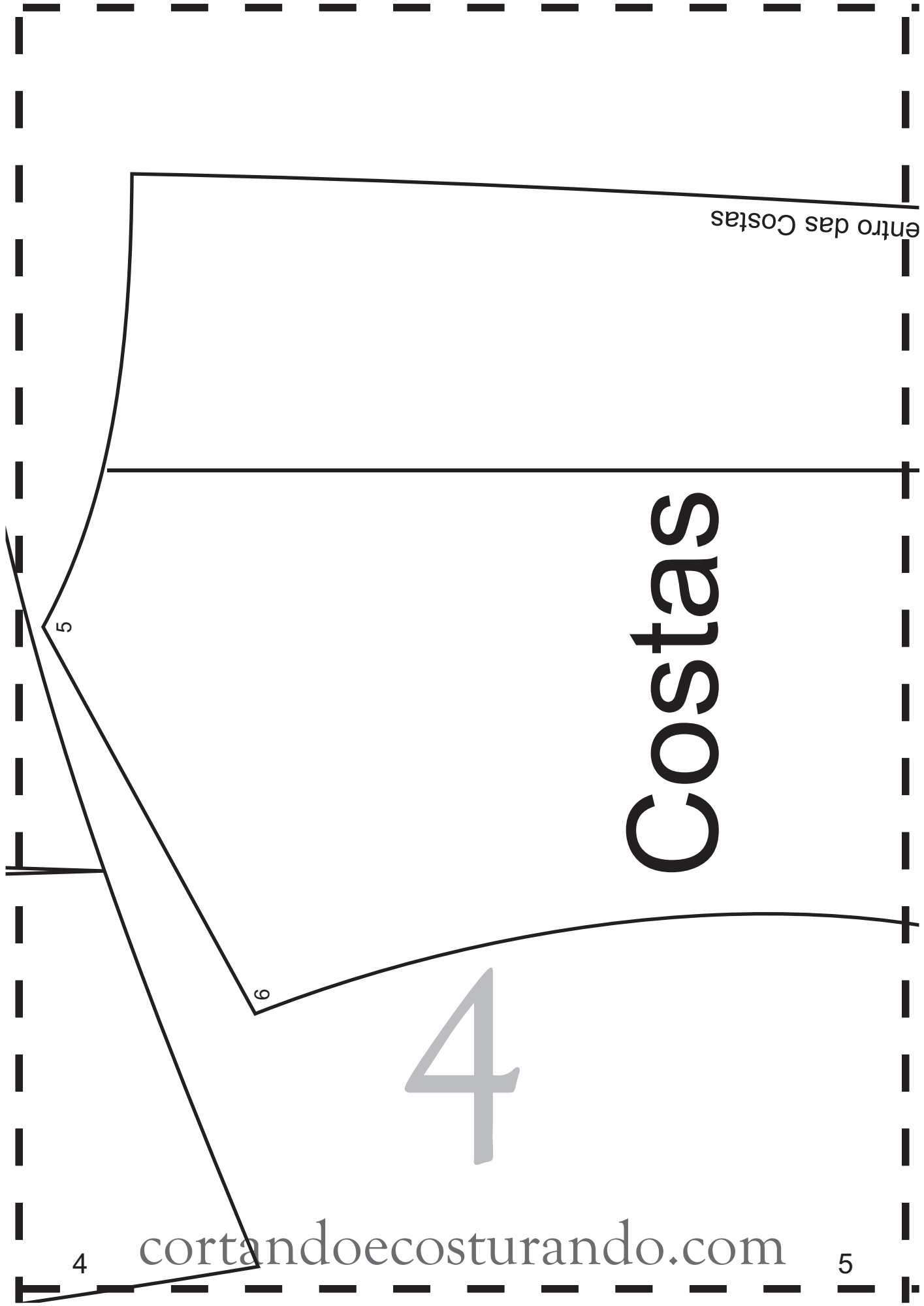



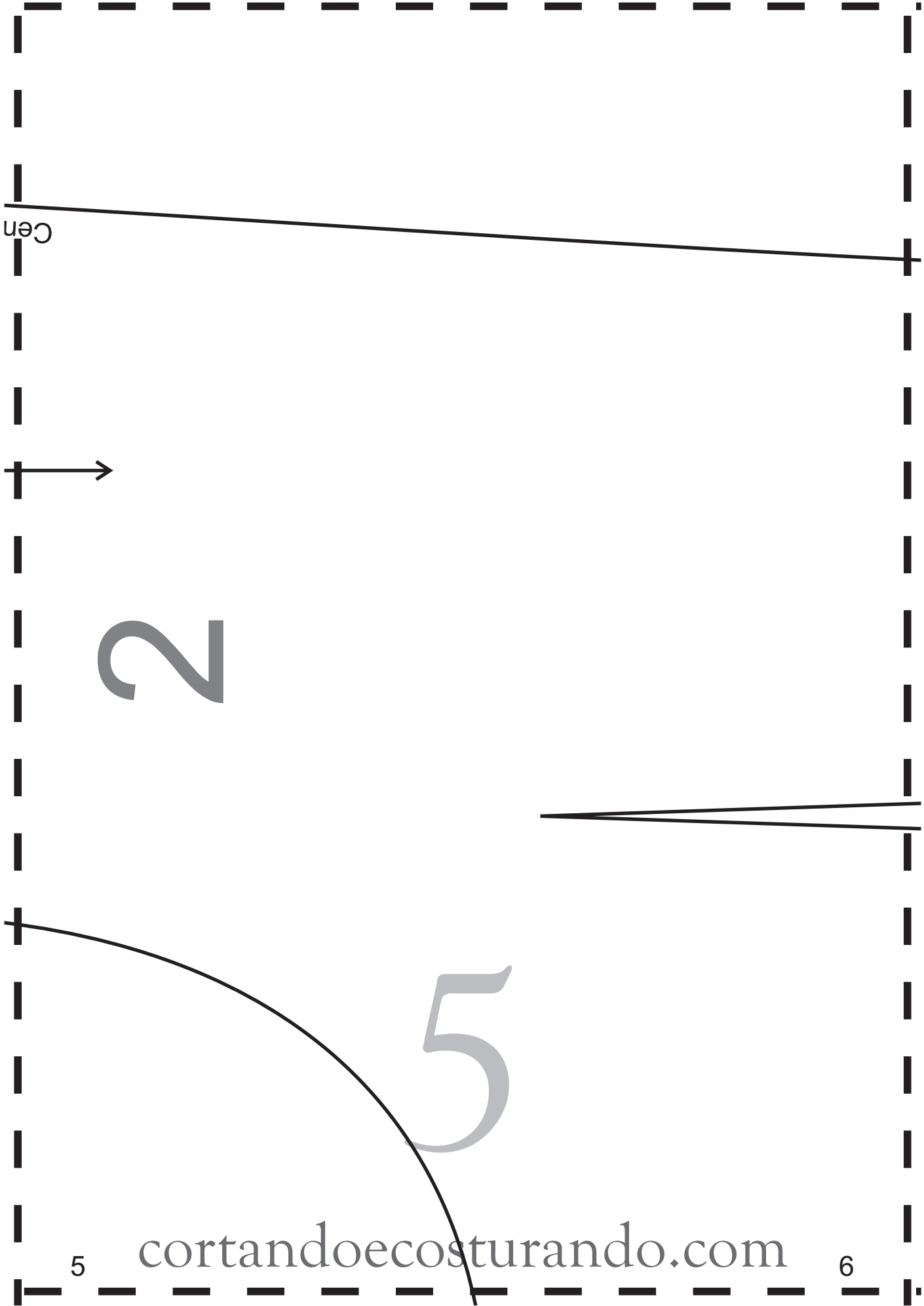

cen

2

5

cortandoeccosturando.com

5

6

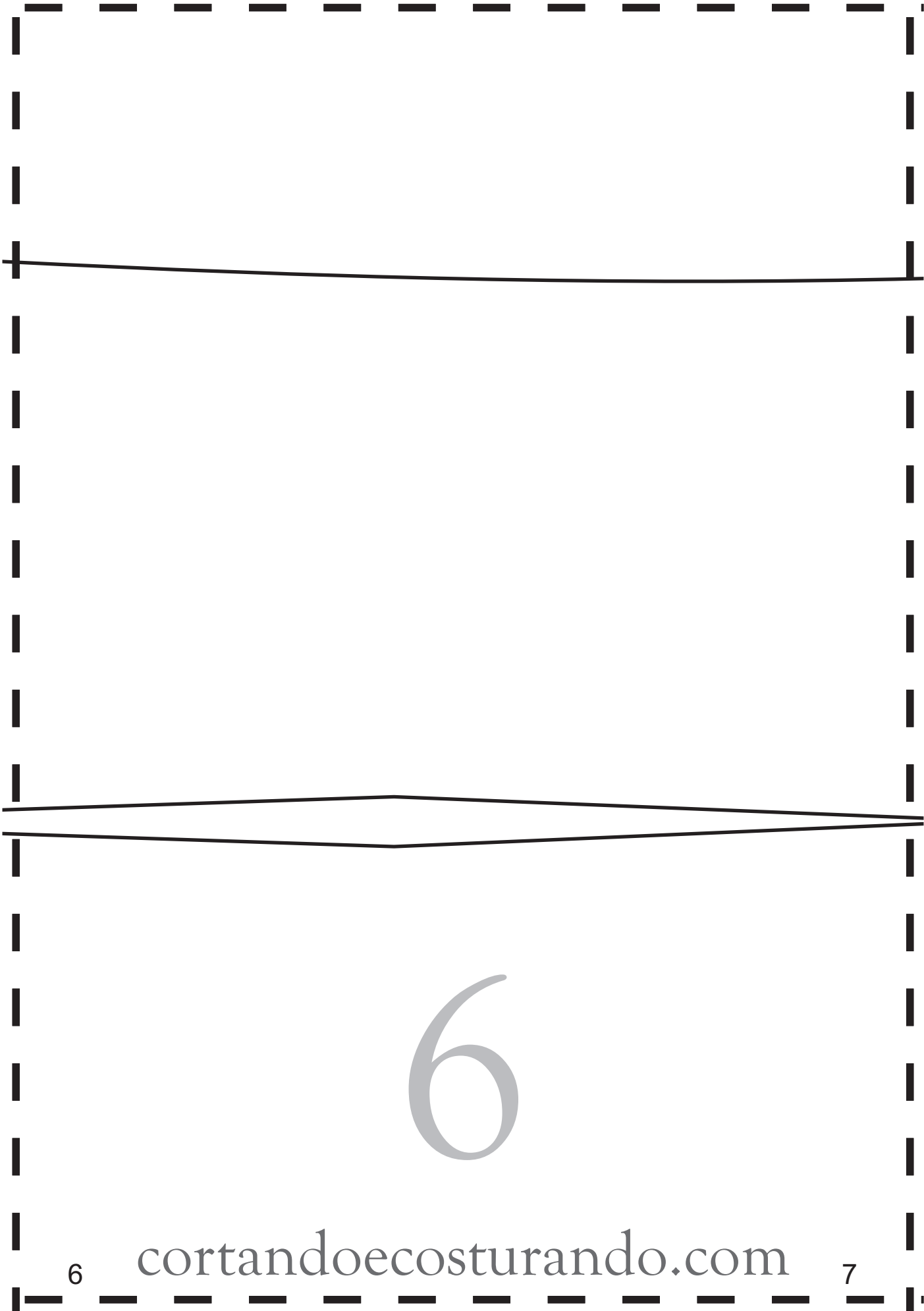

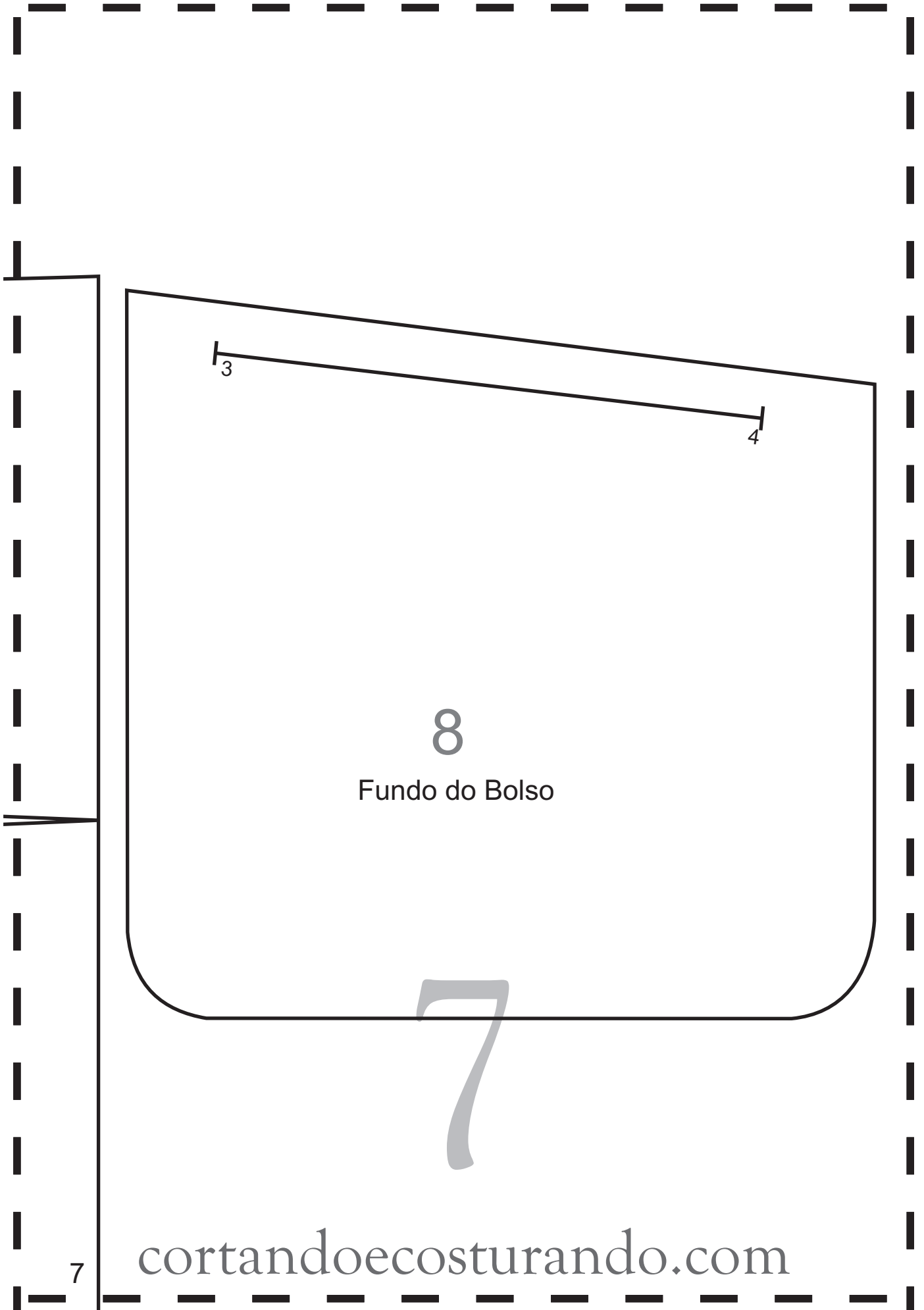

3

4

8

Fundo do Bolso

7

7

cortandoecosturando.com

1

2

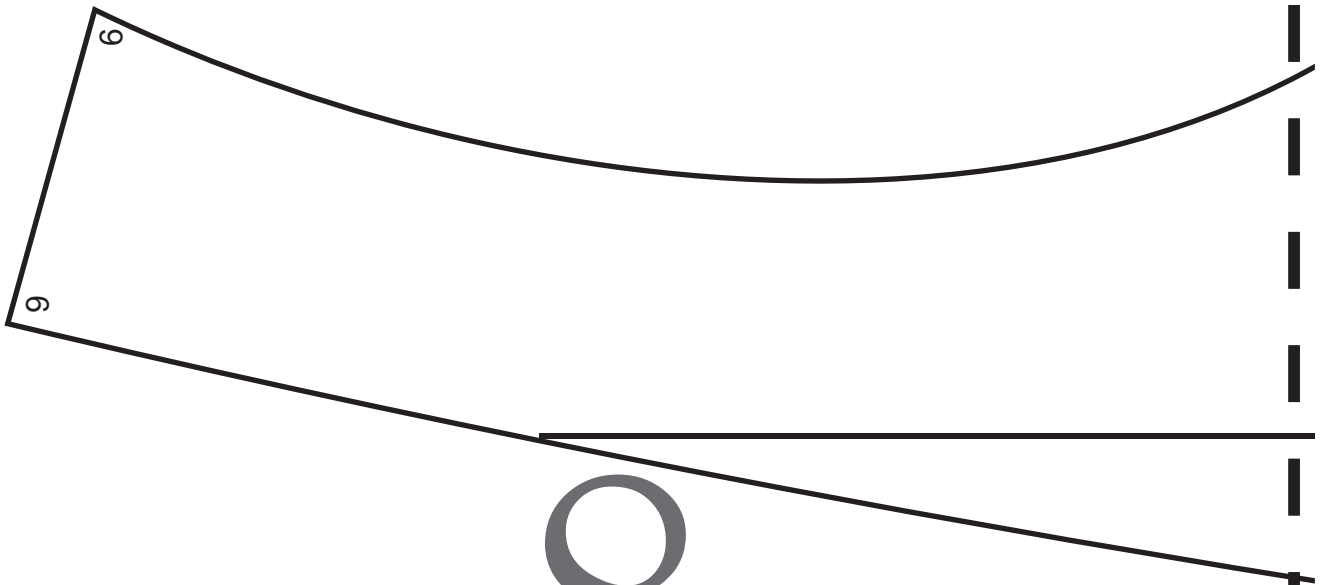

10

[cortandoecosturando.com](http://cortandoecosturando.com)

11

2

3

Forro

4

9

11

12

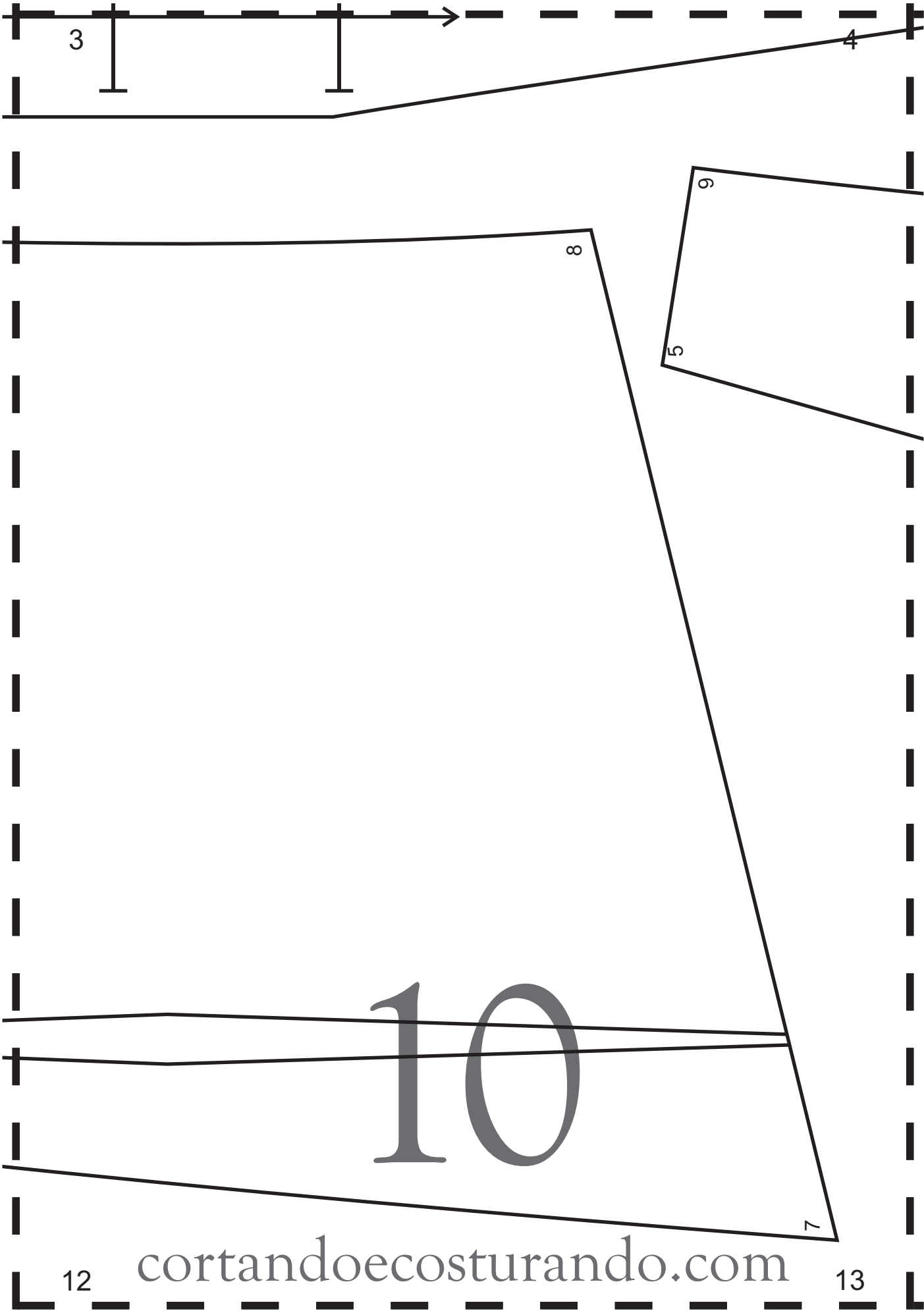

10

4

5

# Revel 3

tréteia

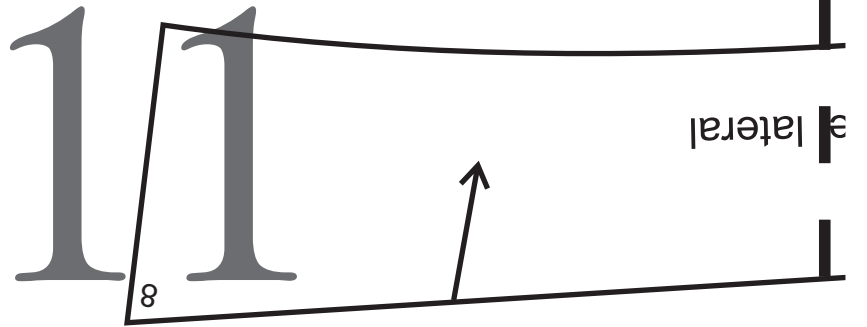
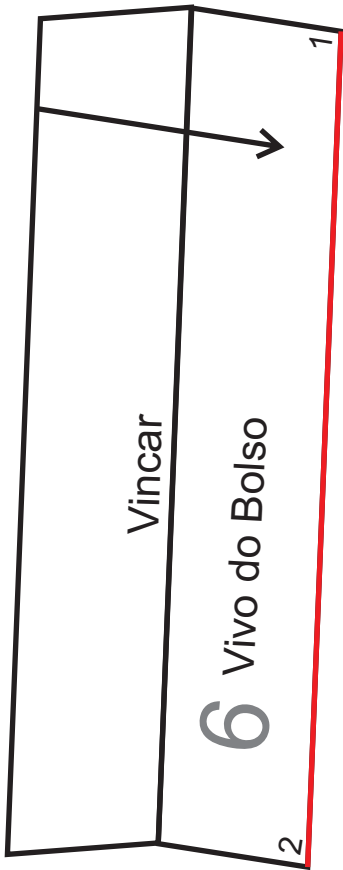

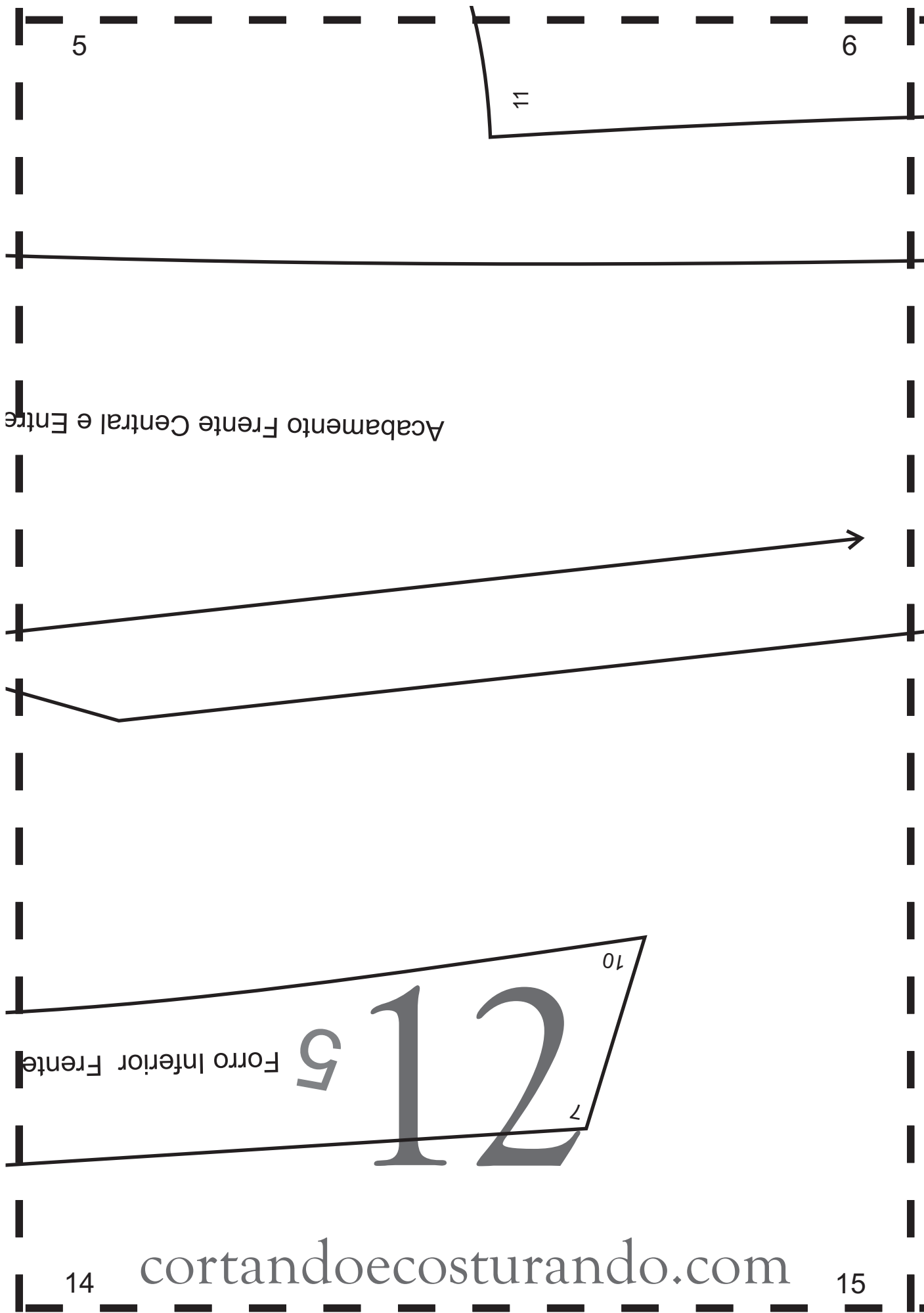

5

6

11

Acabamento Frente Central e Entre

10

5

12

7

Forro Inferior Frente

14

cortandoeocosturando.com

15



6

7

10

1

2

7

Forro do Bolso

13

15

[cortandoecosturando.com](http://cortandoecosturando.com)

16