

cortandoeocosturando.com

Camisa Social Masculina - Tam 4

Tecido - 2m de Tricoline.



Peças do Molde

Frente Esquerda - Cortar 1 vez.

Frente Direita - Cortar 1 vez.

Costas - Cortar 1 vez com o Tecido dobrado.

Pala das Costas - Cortar 2 vezes com o Tecido Dobrado.

Colarinho - Cortar 2 vezes com o Tecido Dobrado.

Pé do Colarinho - Cortar 2 vezes com o Tecido Dobrado.

Punho - Cortar 2 vezes com o Tecido Dobrado.

Carcela - Cortar 2 vezes no Tecido dobrado.

Frente Esquerda

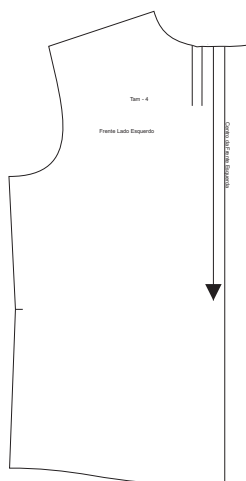

Frente Direita

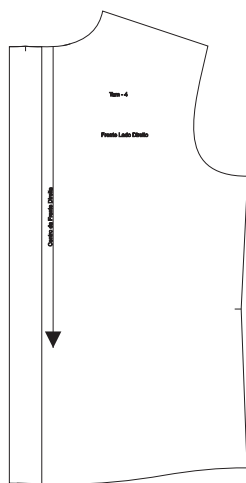

Costas

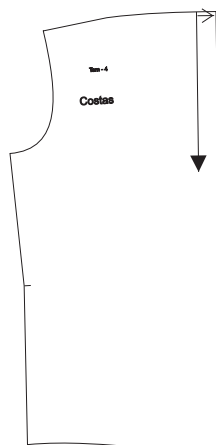

Manga

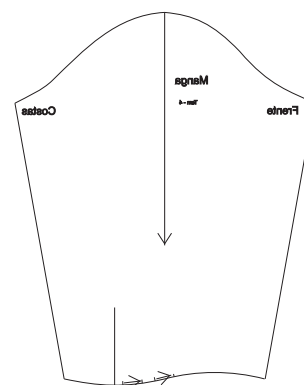

Pala das Costas

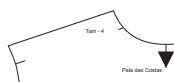

Colarinho

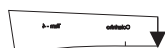

Pé do Colarinho



Punho



Carcela



cortandoe costurando.com

Plano de Corte
2m de Tecido com 1,40m de Largura

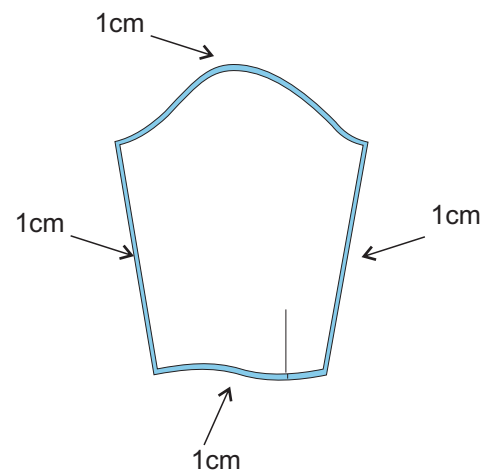
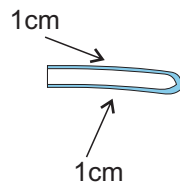
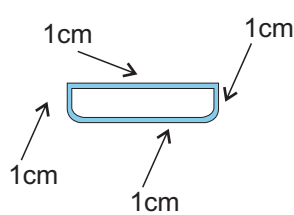
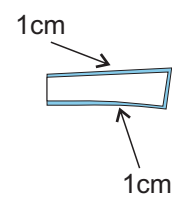
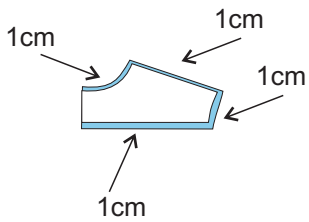
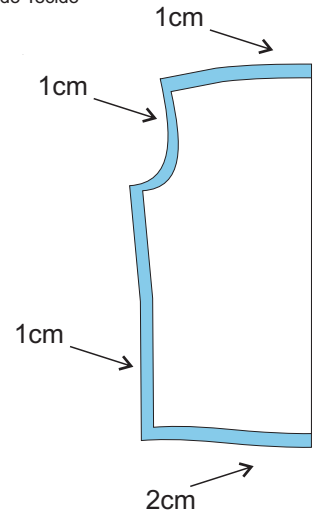
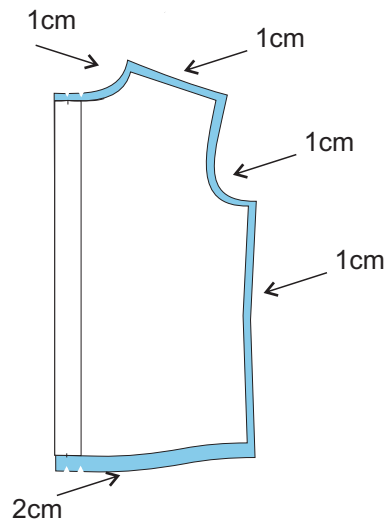
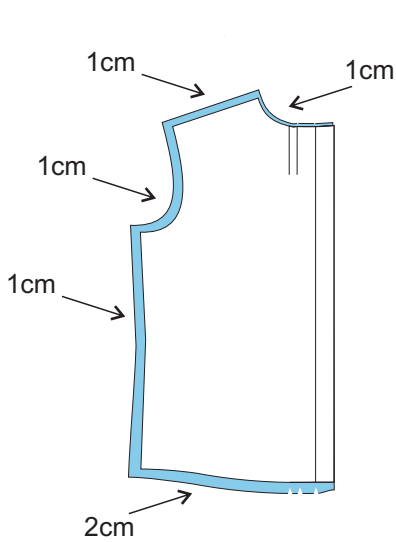
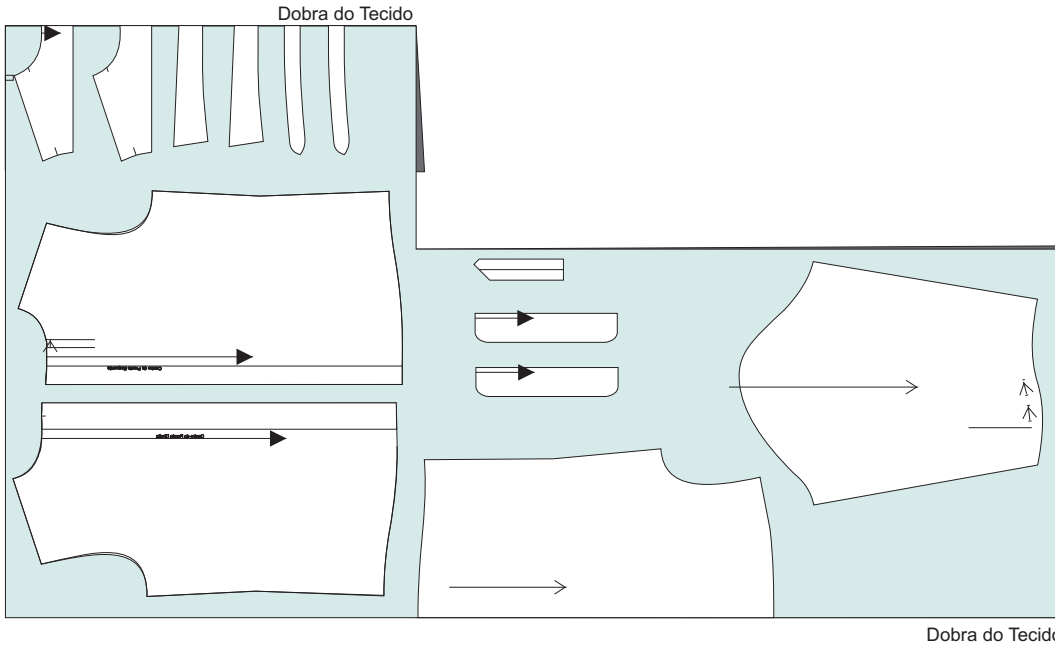

Grade Completa

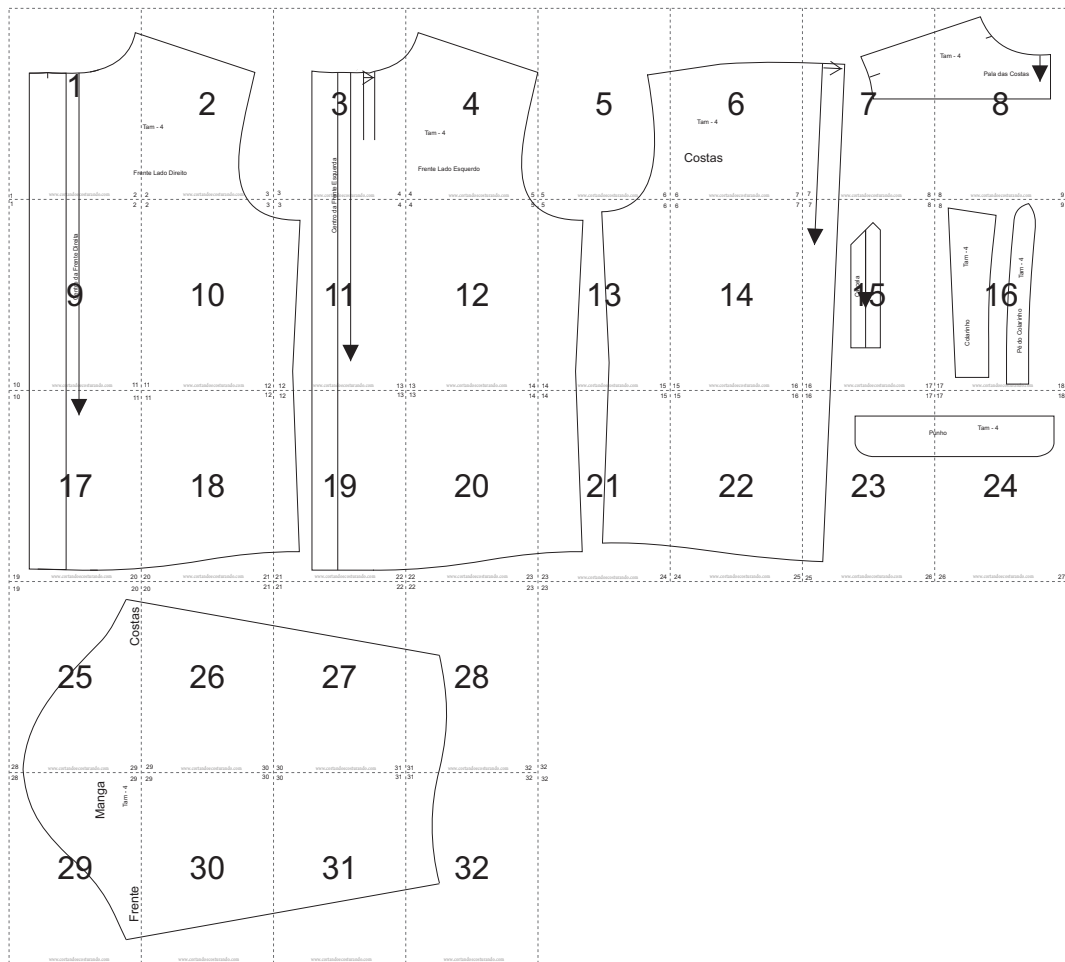

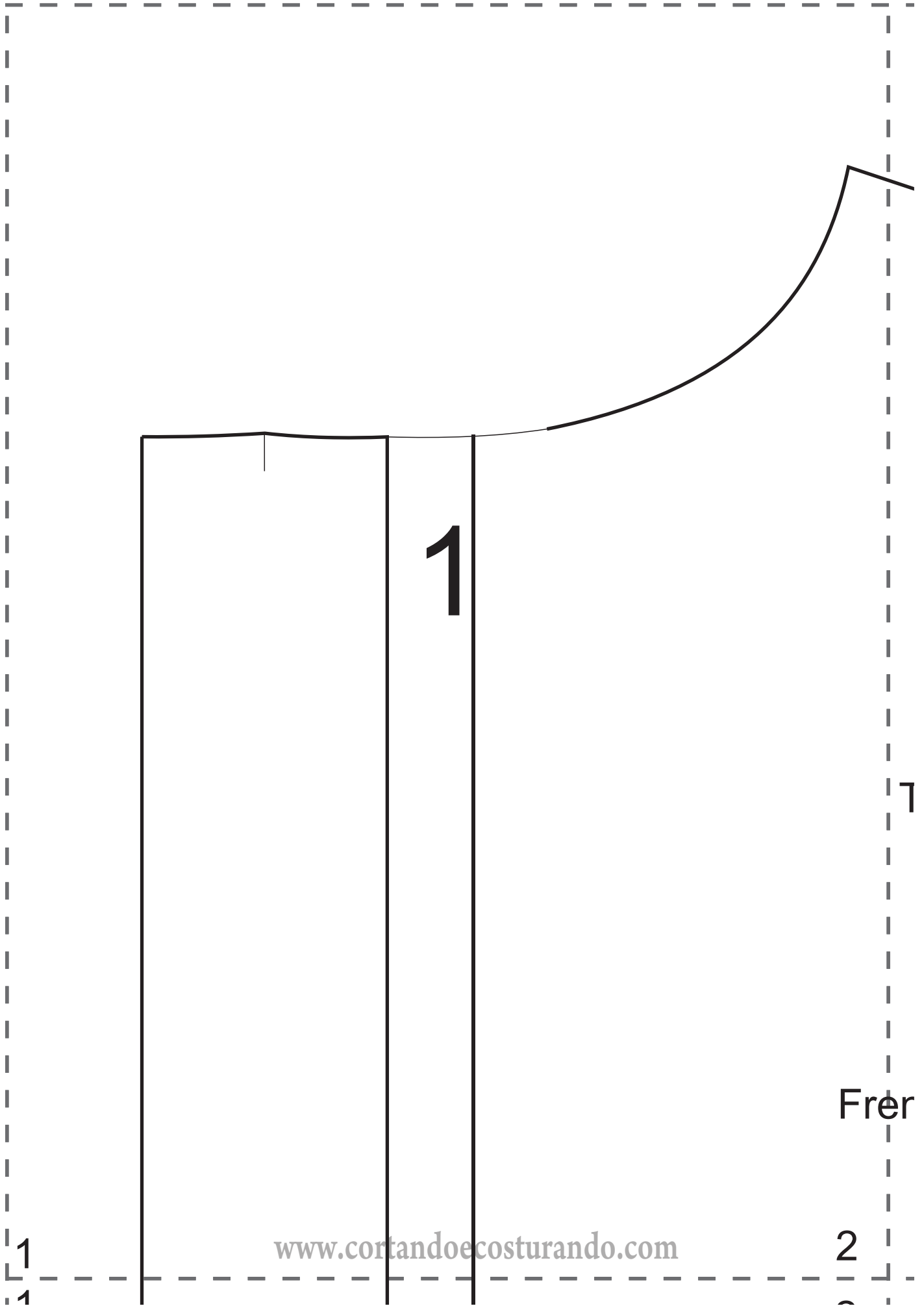

1

1

Frer

1

2

www.cortandocosturando.com

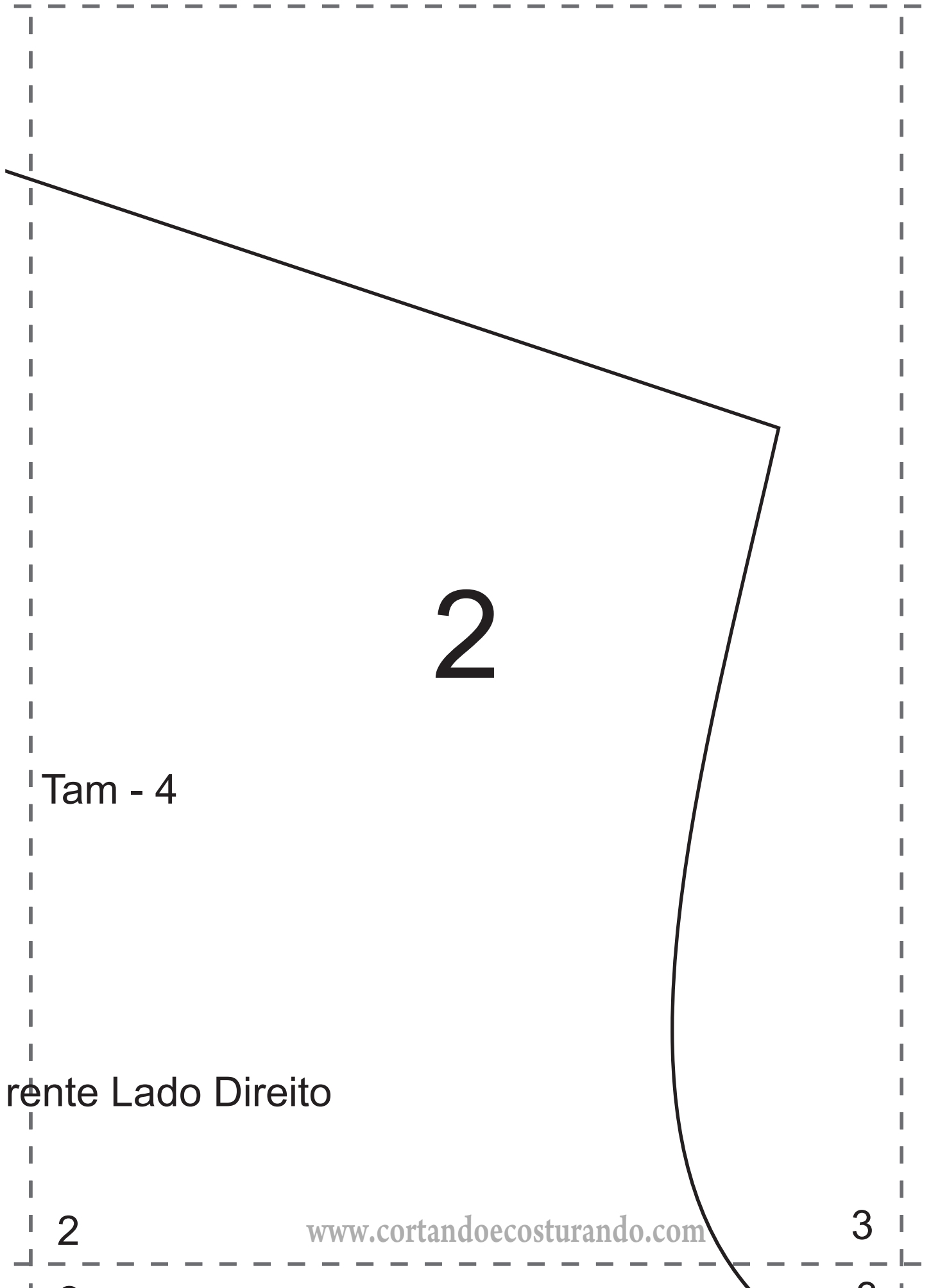

2

Tam - 4

rente Lado Direito

2

www.cortandoecosturando.com

3

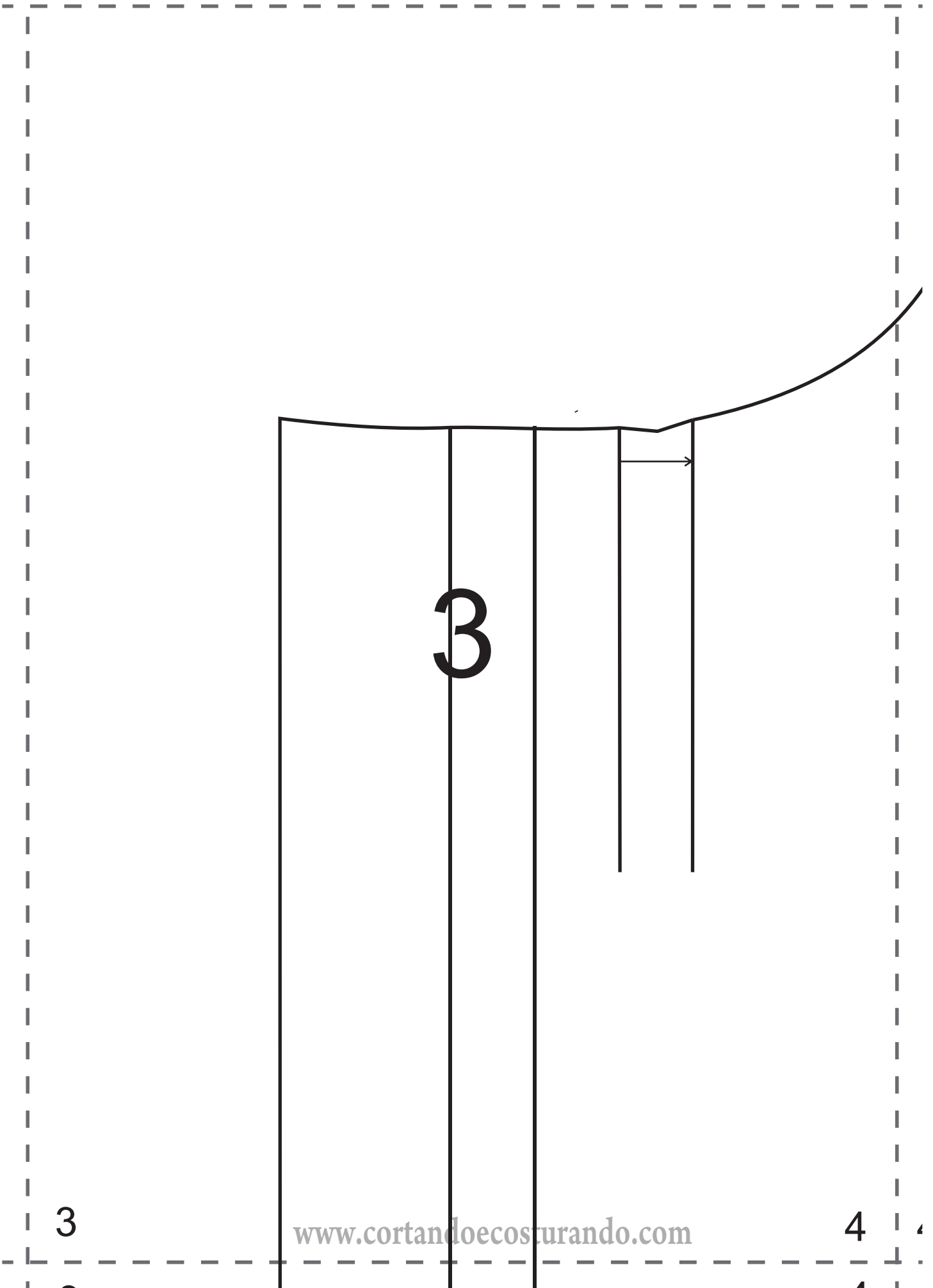

3



3

www.cortandoecosturando.com

4

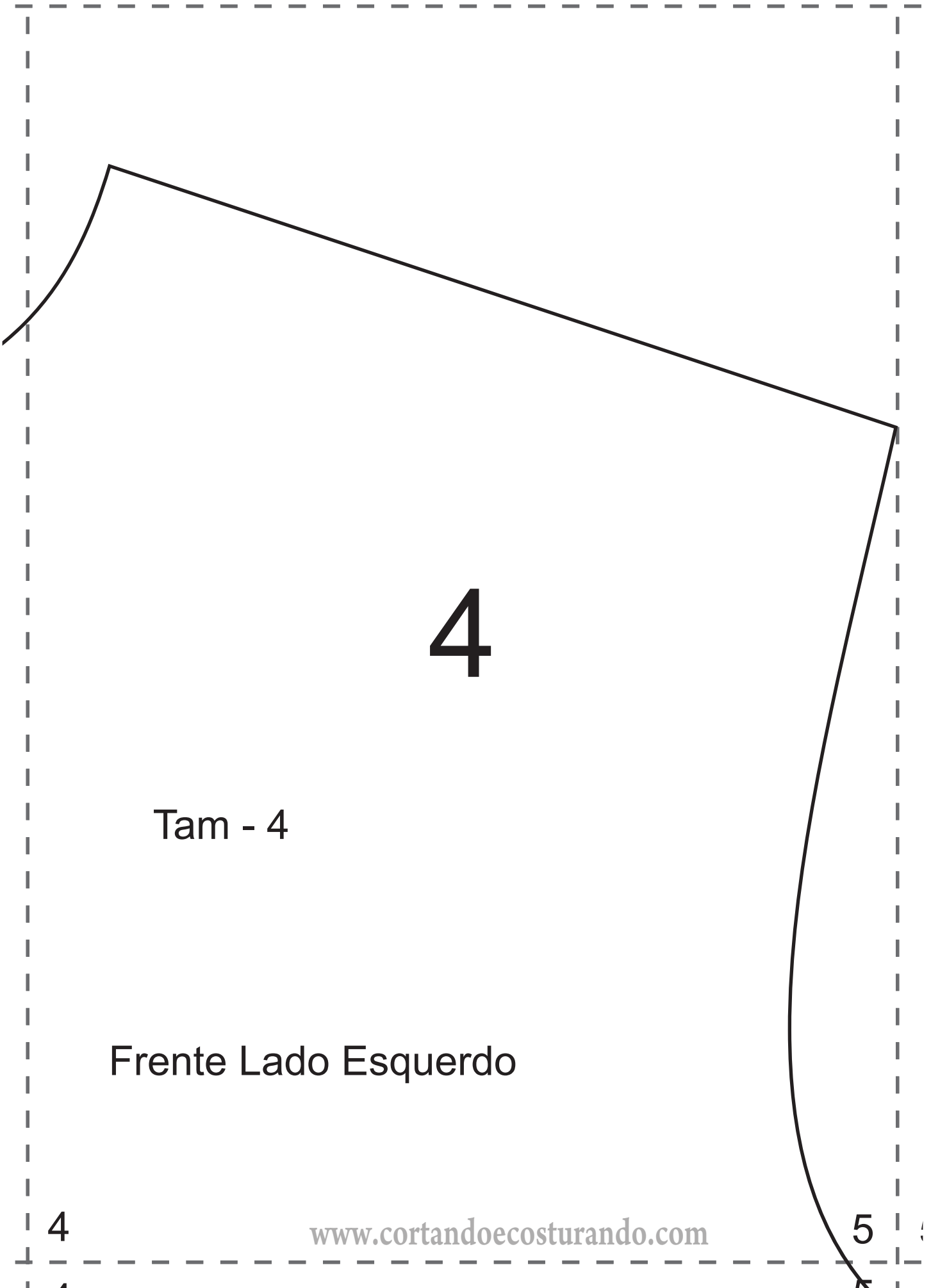

4

Tam - 4

Frente Lado Esquero

4

www.cortandocosturando.com

5

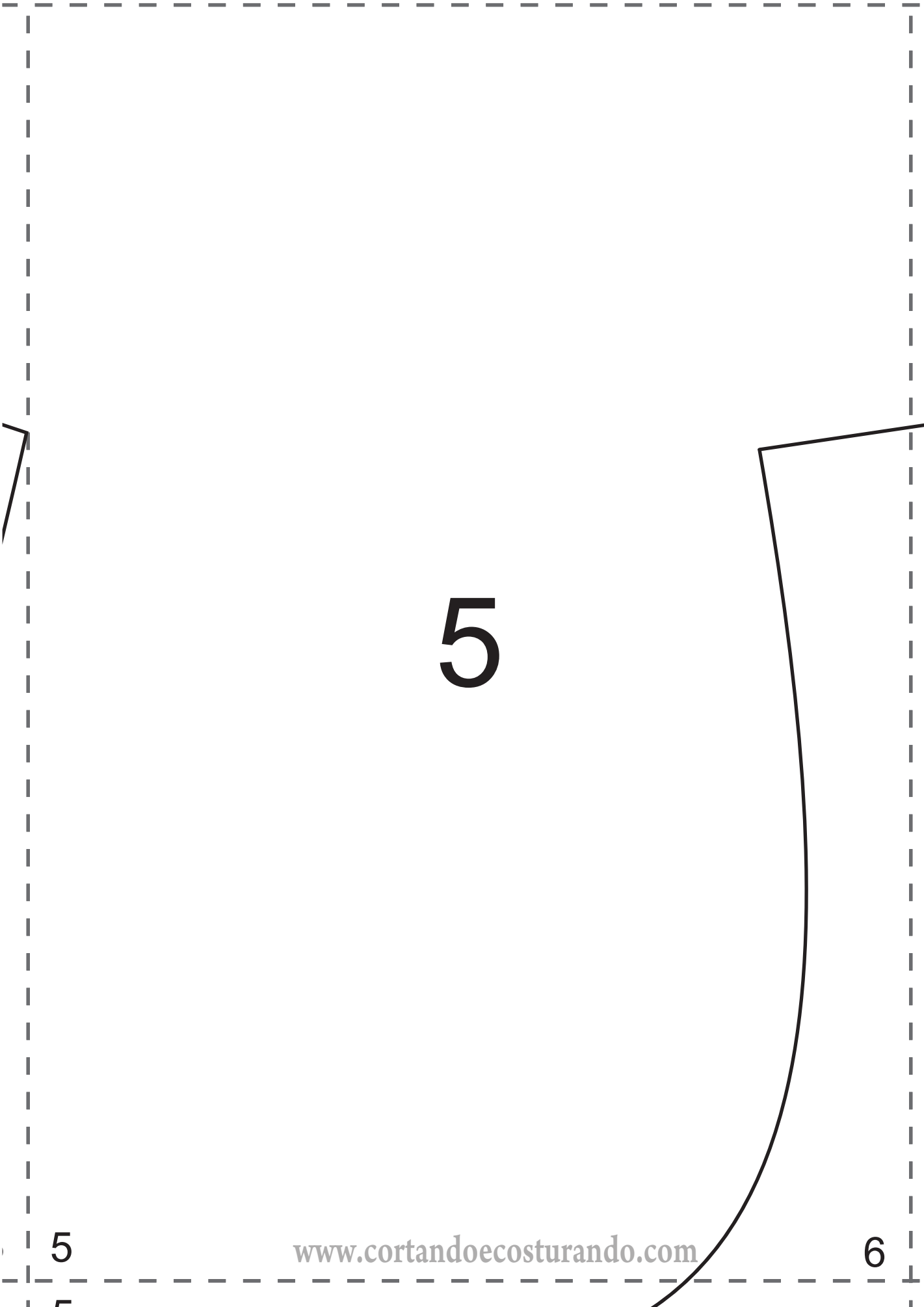

5

5

www.cortandocosturando.com

6

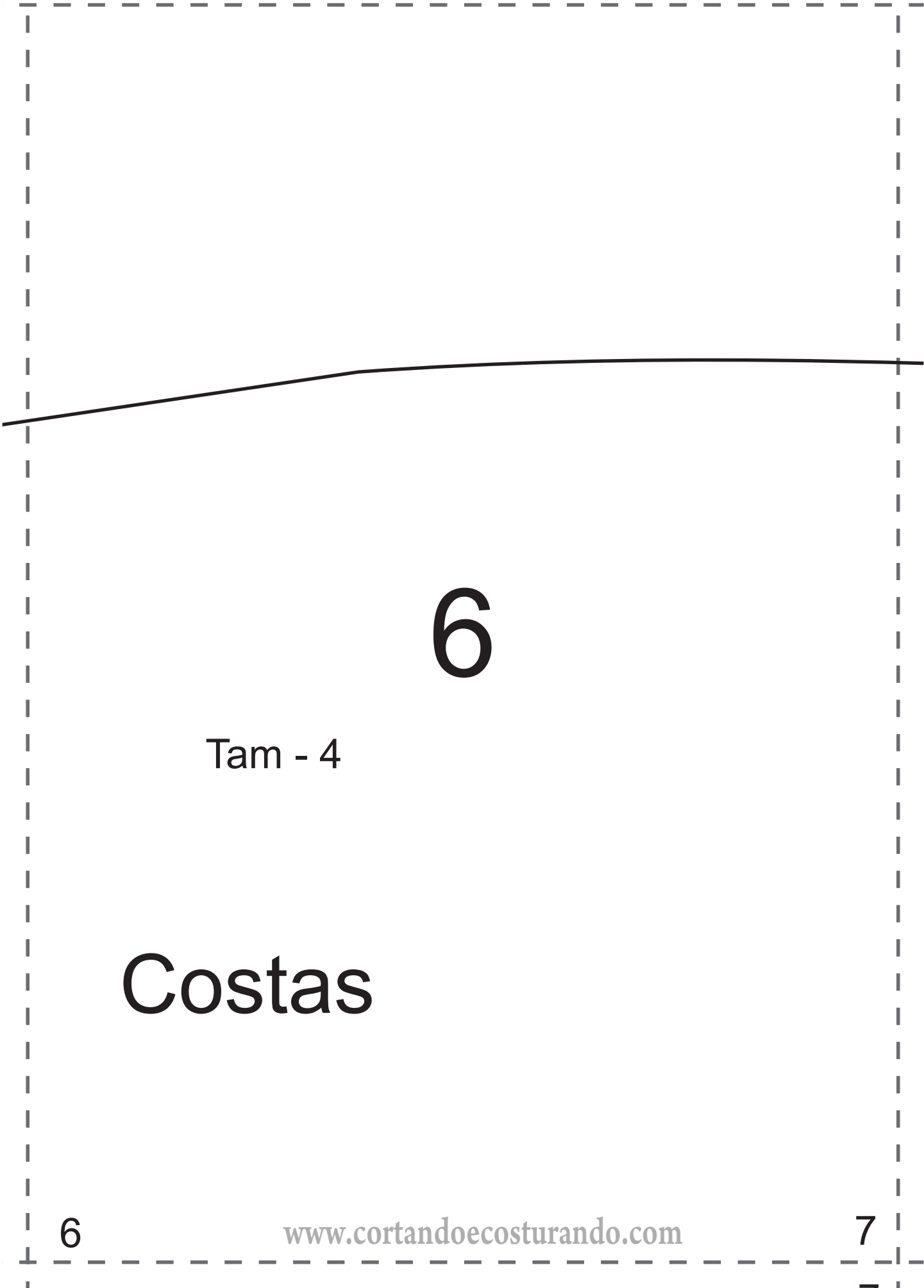

6

Tam - 4

Costas

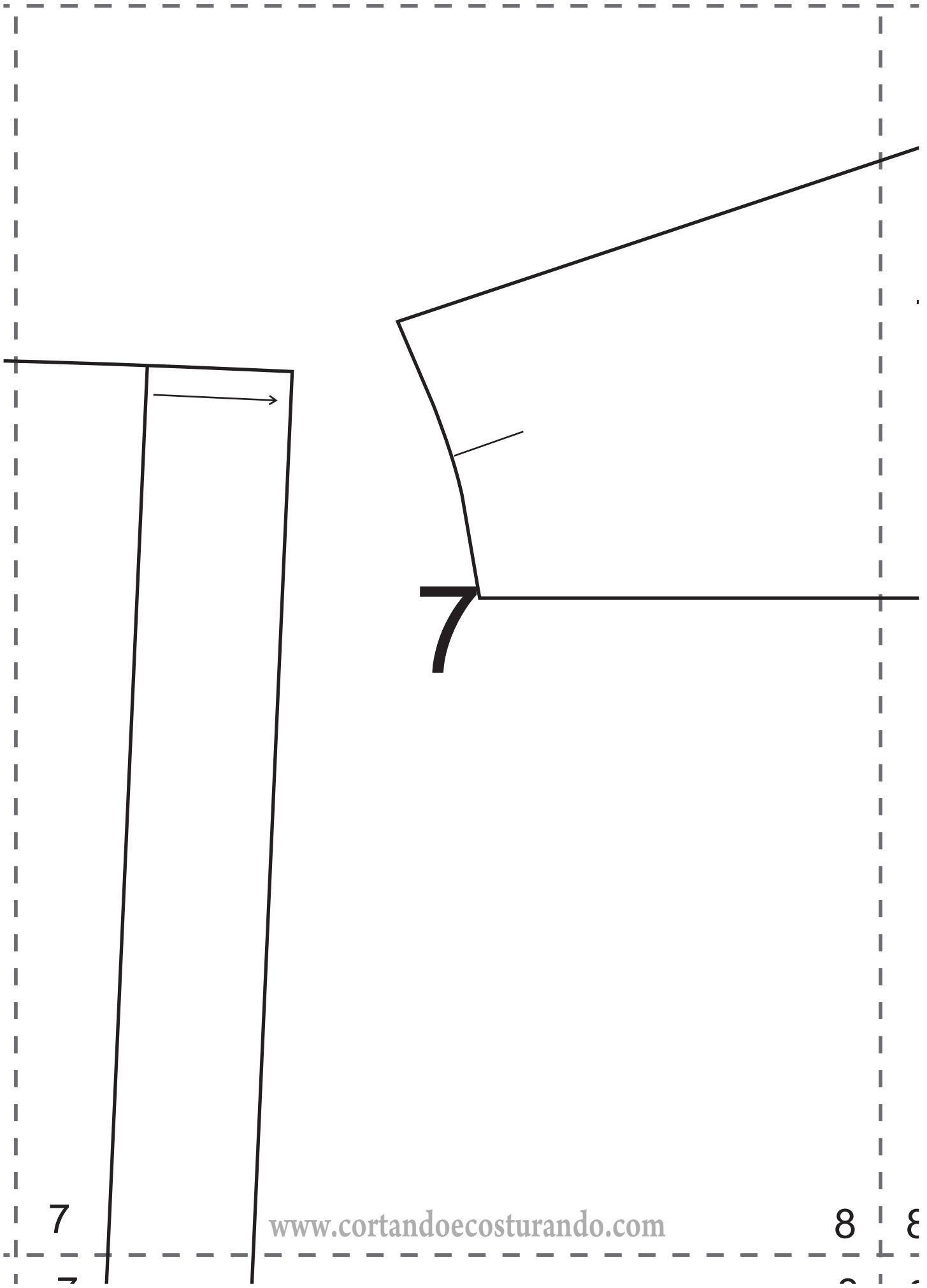

7

8

ε

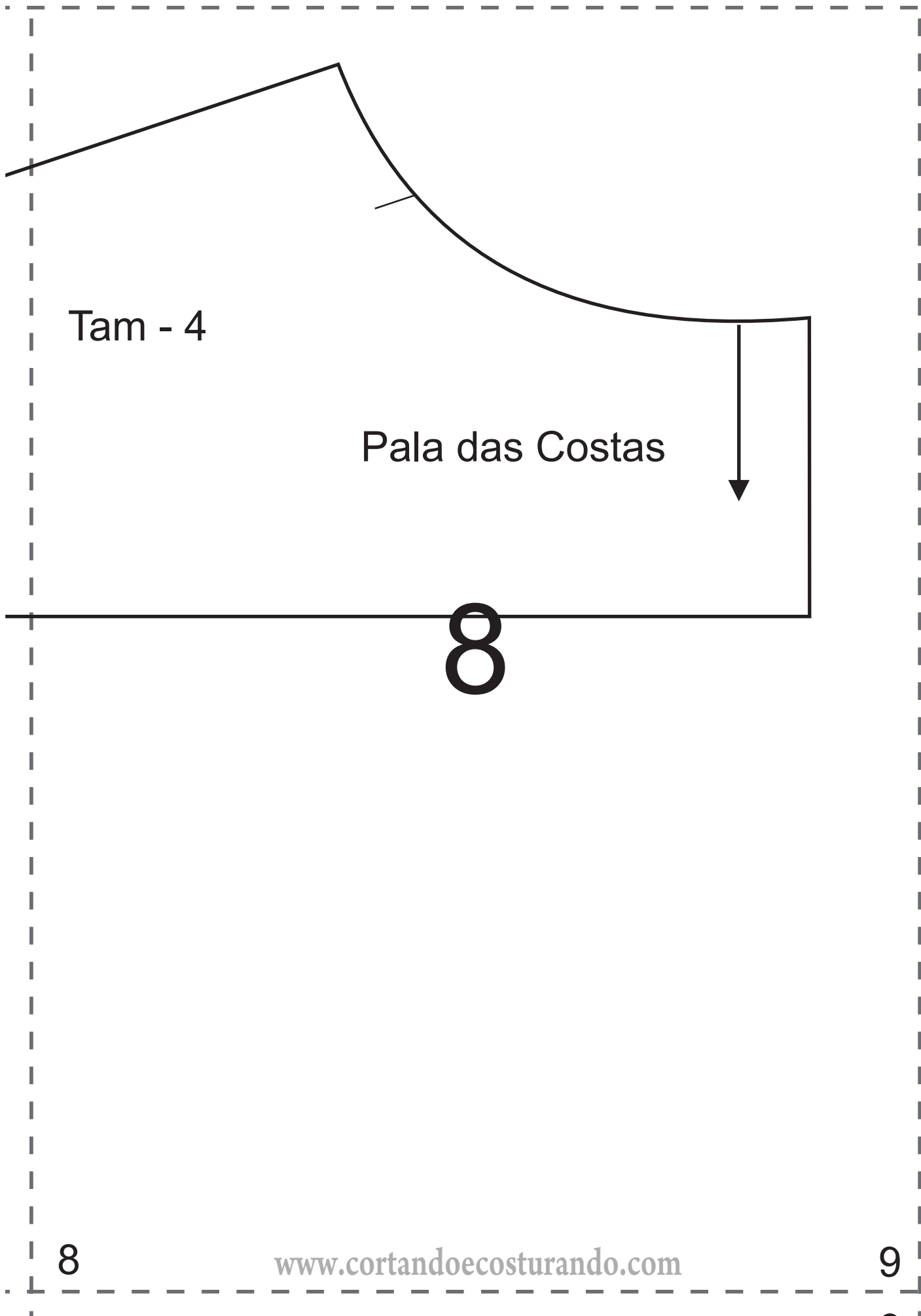

Tam - 4

Pala das Costas

8

1

2

Centro da Frente Direita

10

11

2

3

10

11

www.cortandoeocosturando.com

12

10

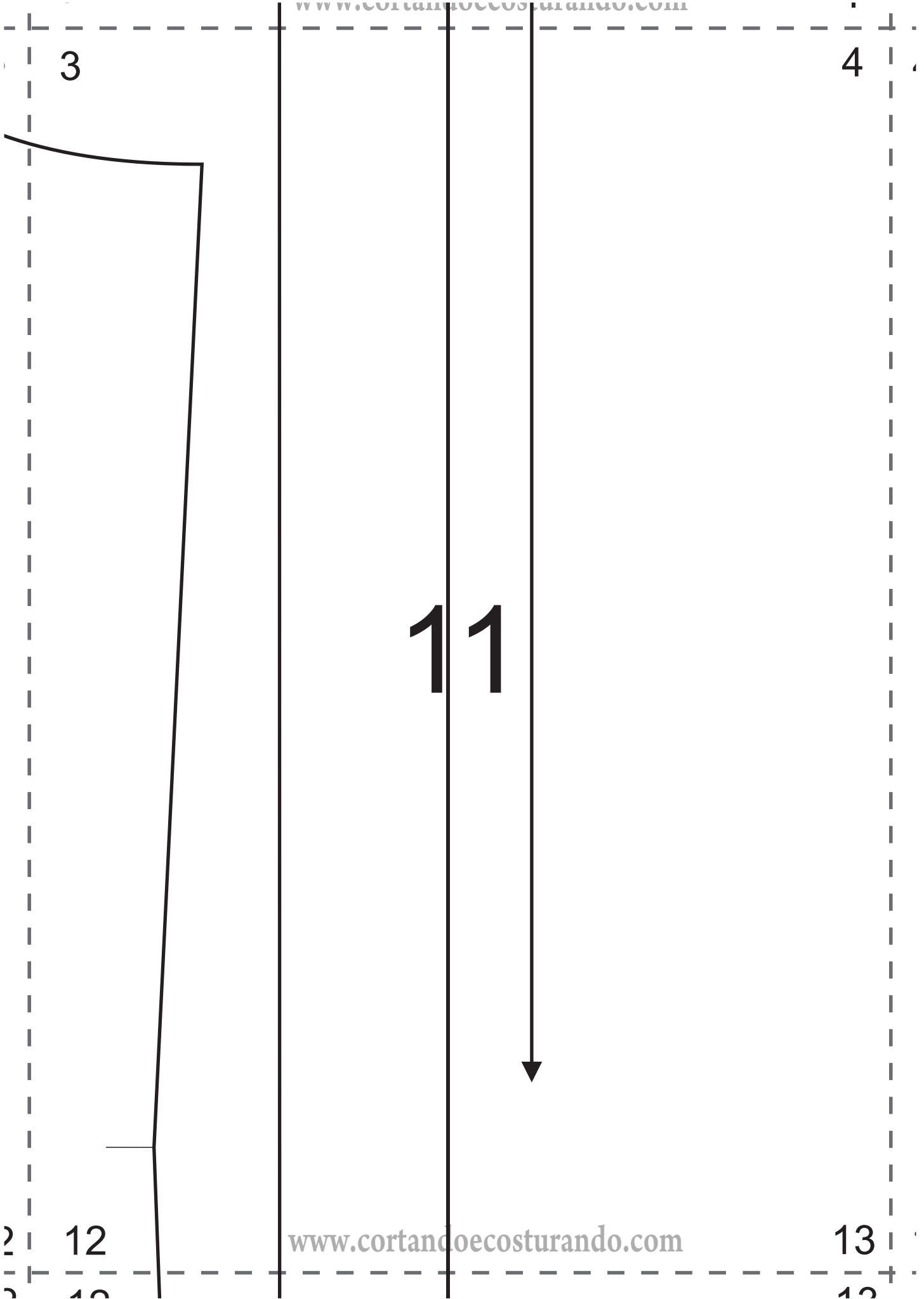

4

5

12

13

14

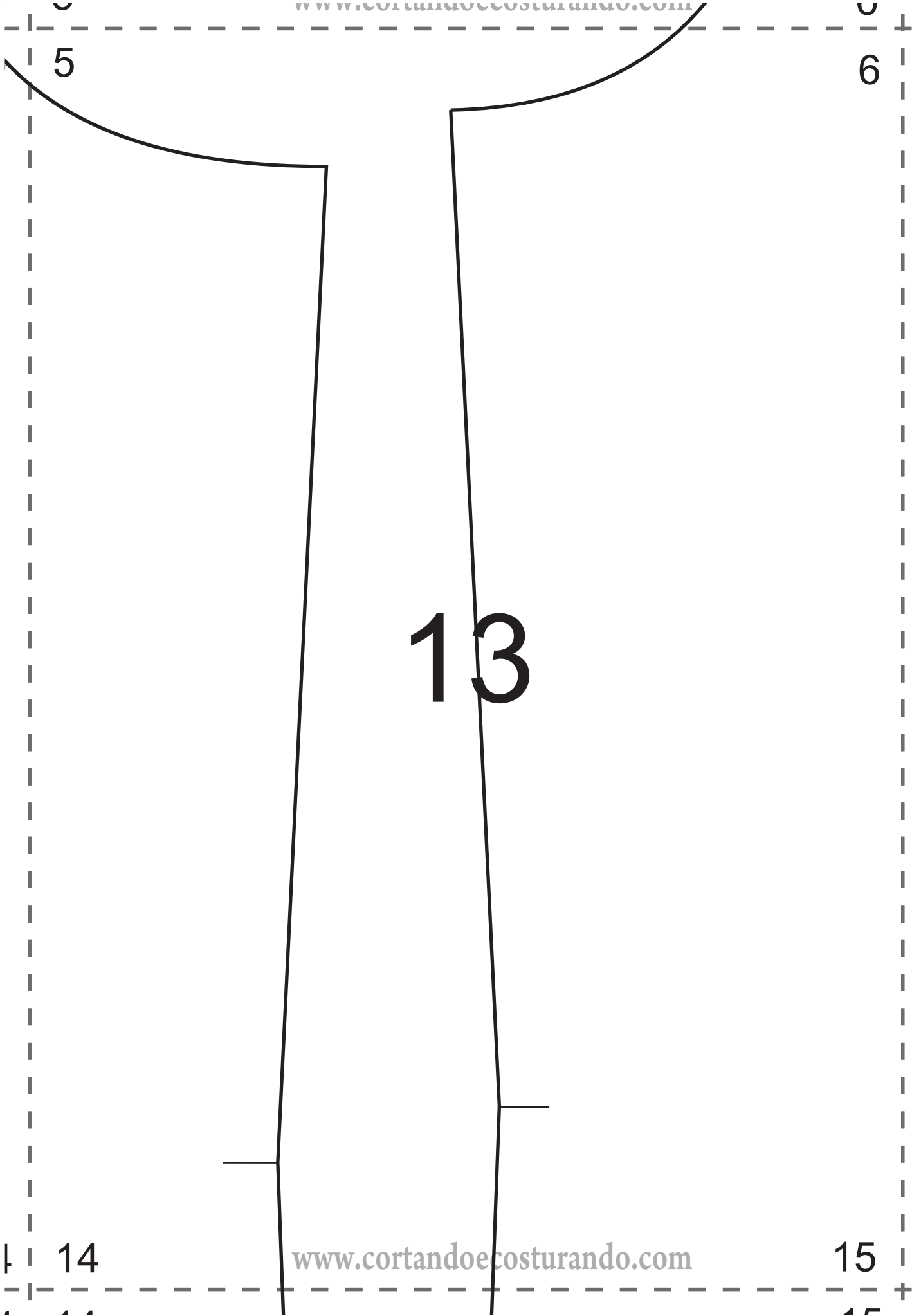

5

6

13

14

15

14

7

8

Carcela

15

16

17

8

9

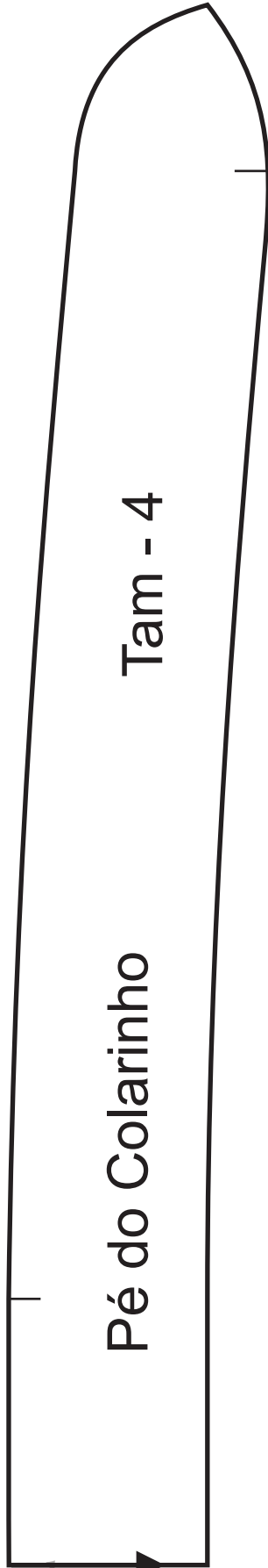
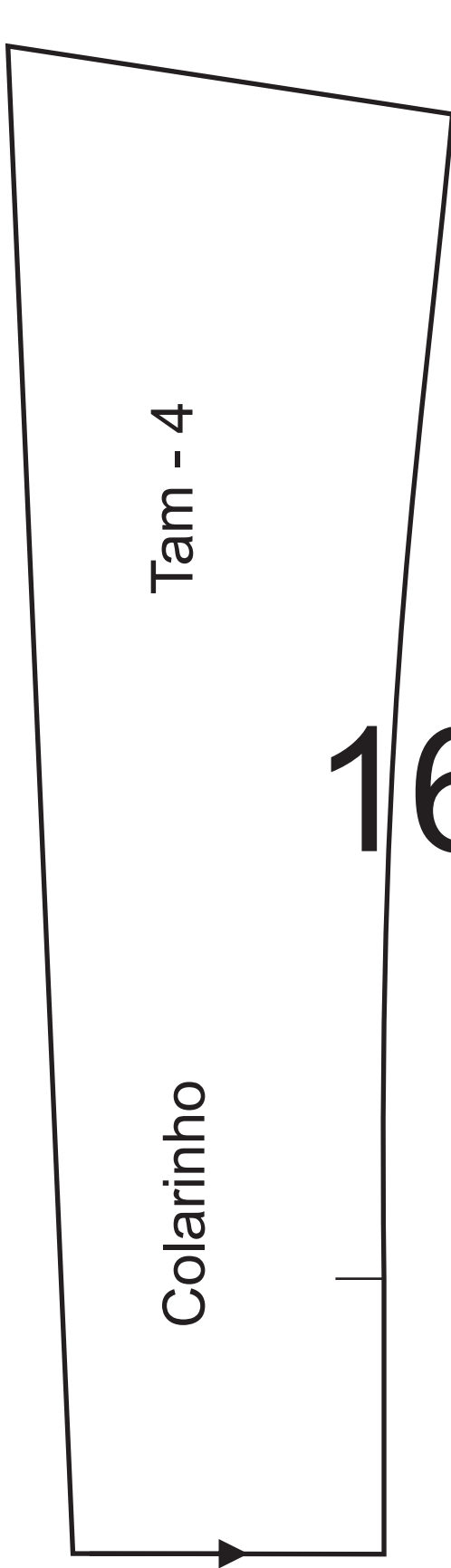

17

18

10

11

17



19

20

1 11

12

18

20

21 12

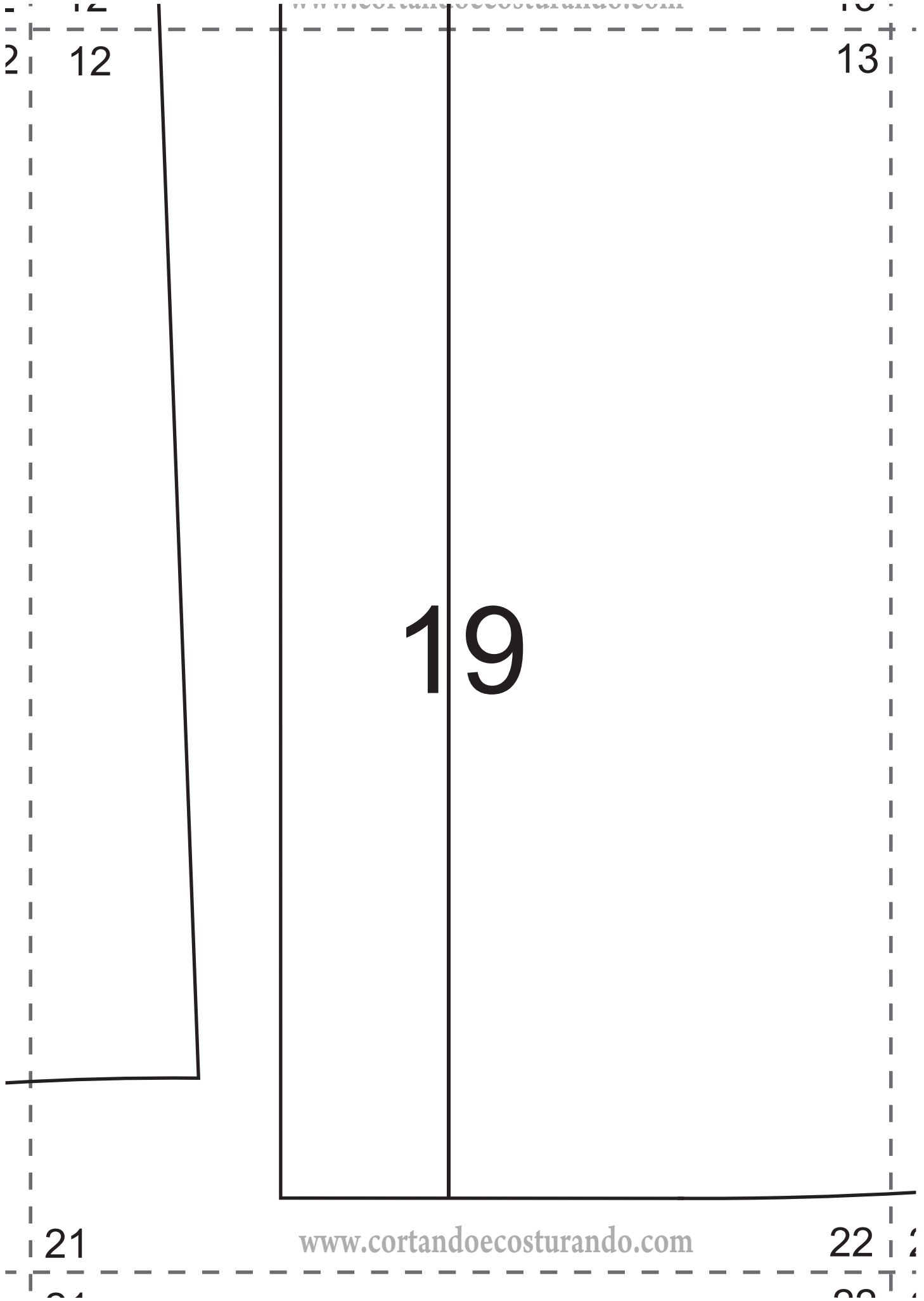

3 13

14

20

22

www.cortandoecosturando.com

23

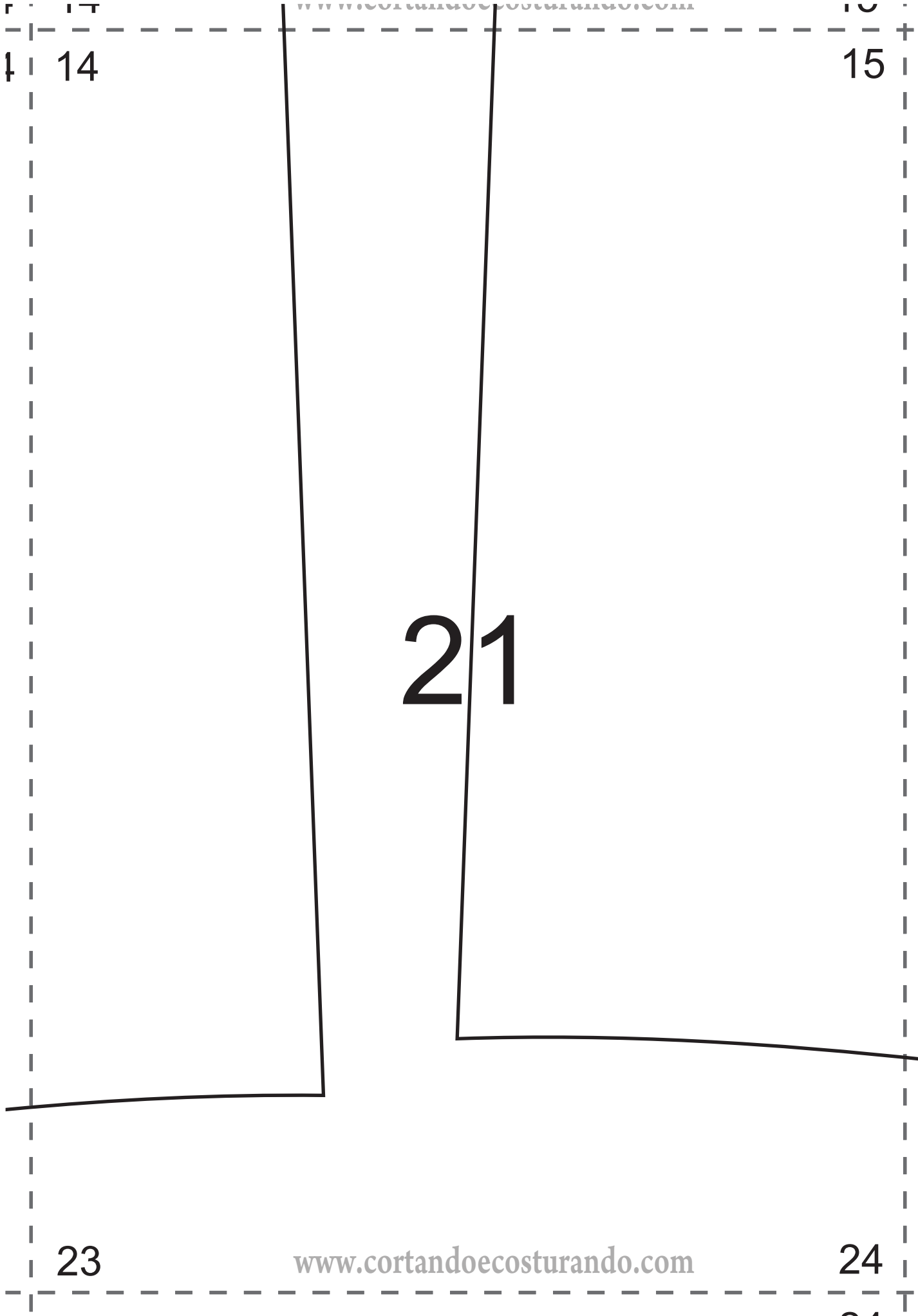

14

15

21

23

24

15

16

22

24

25

16

17 1

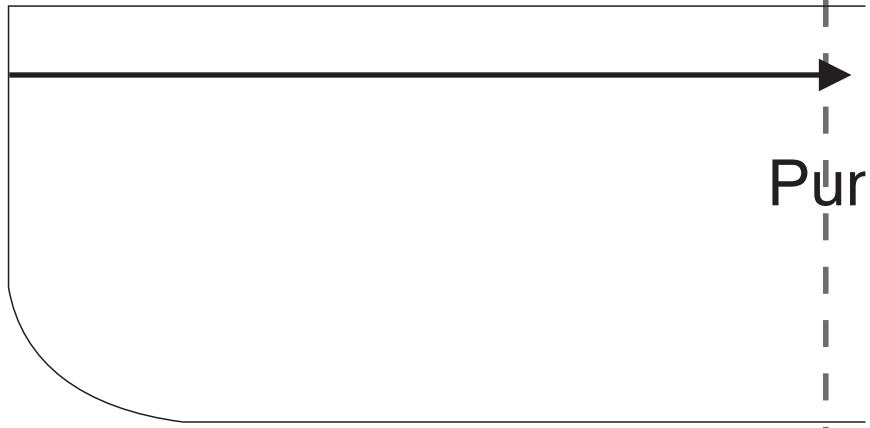

23

5 25

26

7 | 17

18



punho

Tam - 4

24

26

27

19

20

25

Costas

28

29

www.cortandoeconomizando.com

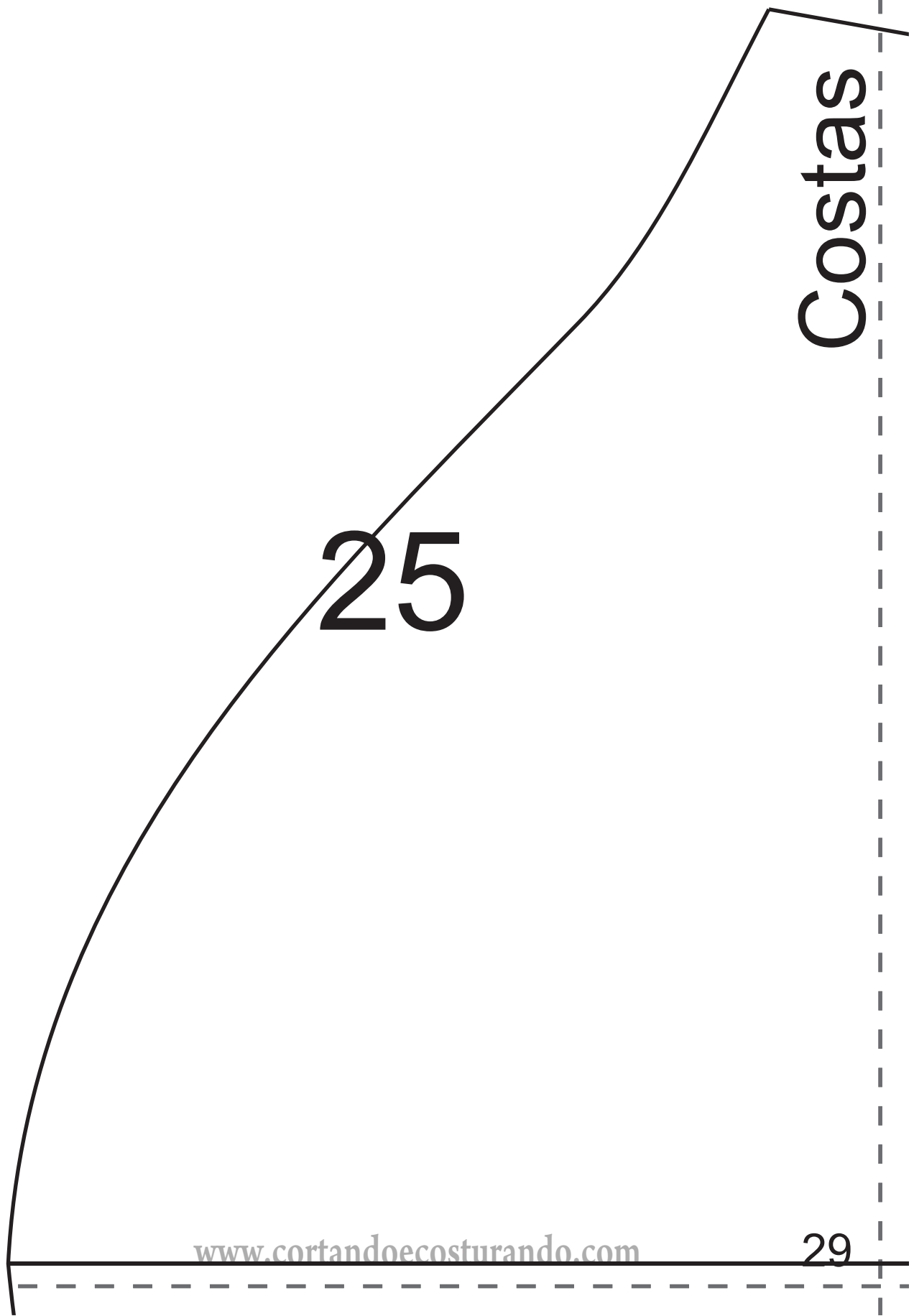

20

21

26

29

30

21

22

21

22

27

30 →

31

30

31

22

23

28

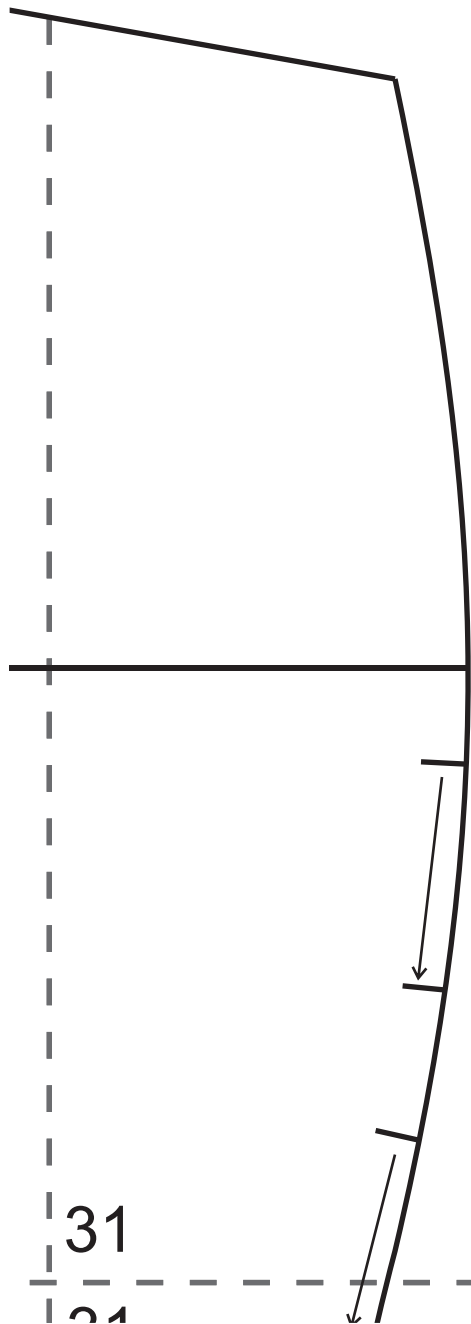

31

32

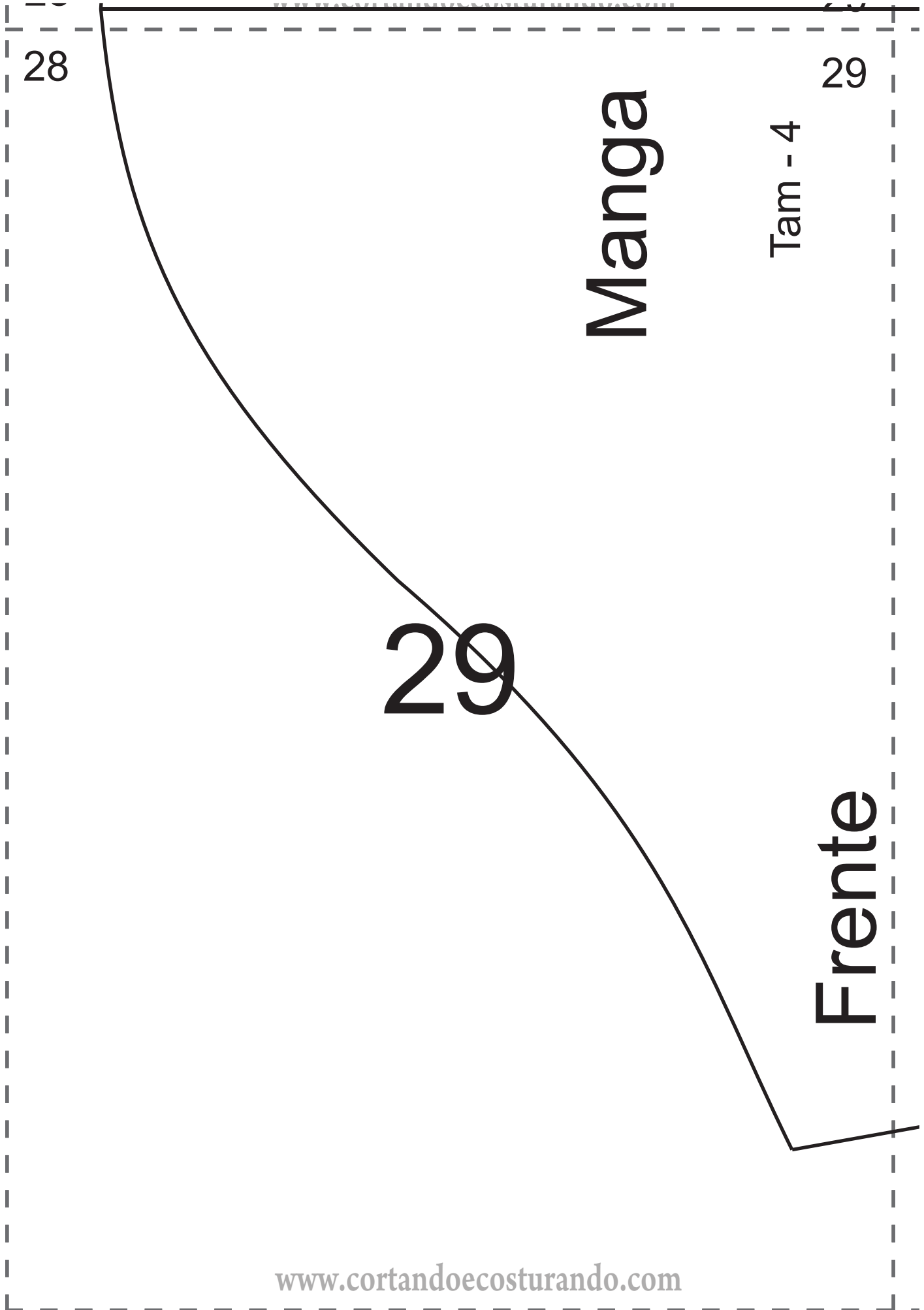

28

29

Manga

Tam - 4

29

Frente

29

30

30



30

31

31

31

32

32

